

[REDACTED]

[REDACTED]

OPERATION HARDTACK

DRAFT COPY

411050

PROJECT 2.8

WT-1625 Draft

RG 181 AGENCY/NRDL

Location SAN BRUNO FRC

Access No. 65-A-735 Box 1/2

Folder AIRCRAFT AND

ROCKET FALLOUT

AIRCRAFT AND ROCKET FALLOUT

S. L. Whitcher
R. R. Soule, Project Officer

U. S. Naval Radiological Defense Laboratory
San Francisco 24, California

August 1959

CLASSIFICATION CANCELLED
WITH DELETIONS
BY AUTHORITY OF DOE/OC

J. Rahn 8/10/92

memo DNA Swisher
to DOE dtd 6/18/92

J. Diaz 8-11-92

BEST COPY AVAILABLE

COORDINATING OFFICE
[REDACTED]

J. Diaz 1/10/92

EXCLUDED FROM AUTOMATIC REGRADING

[REDACTED]

[REDACTED]

ABSTRACT

The primary objective of the project was to estimate the partition of Sr^{90} and Cs^{137} between the local and long-range fallout formed by megaton-range nuclear detonations over land and water surfaces. A secondary objective was to determine the spatial distribution of radioactivity (and particles) in the nuclear clouds a few minutes after stabilization. It was planned to achieve these objectives by radiochemical analyses and particle size measurements on the following types of samples:

1. Samples of the particles and radioactive gases present in the upper portions of the clouds to be collected by high flying aircraft.
2. Samples of the particulate matter in the clouds to be collected along nearly vertical flight paths, at several different distances from the cloud axis, by rocket-propelled sampling devices.
3. Samples of the fallout to be collected at an altitude of 1,000 feet by low-flying aircraft.

The project participated in a megaton shot (Koa) fired over a coral island **DELETED** shot (Walnut) fired from a barge in deep water, and a 9-MT shot (Oak) fired over a coral reef in shallow water. The aircraft sampling program was generally successful, and fairly complete sets of both cloud and fallout samples were collected on each shot. The rocket program was unsuccessful due to a variety of equipment malfunctions.

SAN BRUNO FILE

[REDACTED]

The gas samples were analyzed for radioactive krypton and the cloud and fallout samples were each analyzed for Sr^{90} , Cs^{137} and several other nuclides selected to give information on fractionation. Fall rate and size distribution measurements were made on the particle samples from the land surface shot. The combined analytical data was used to estimate the distribution of Sr^{90} and Cs^{137} between the local and long-range fallout.

The results indicate that for water shots, around one-half of the Sr^{90} and two-thirds of the Cs^{137} formed will be dispersed over distances greater than 4,000 miles. Corresponding figures for a coral land surface are one-fifth for Sr^{90} and one-half for Cs^{137} . Radionuclide fractionation was pronounced in the land surface shot. The local fallout was depleted in both Sr^{90} and Cs^{137} and the upper portions of the clouds were enriched. Fractionation was much less for the water shot.

There are no results to be reported on the spatial distribution of radioactivity in the clouds since this part of the project was dependent on the rocket samples.

It is recommended that a similar project, with particular emphasis on land detonations, be included as part of the program if future weapons tests are scheduled. Such a project could provide a valuable check on the HARD-TACK data and would be relatively inexpensive if only the long-lived nuclides were determined.

SAN BRUNO FRC

[REDACTED]

PREFACE

In the formulation of this project, three distinct parts were established: rocket fallout sampling, aircraft fallout sampling and sample analysis, data interpretation and report preparation. Responsibility for the conduct of rocket sampling was assigned to the University of California Radiation Laboratory (UCRL); responsibility for the conduct of the aircraft sampling was assigned to the Los Alamos Scientific Laboratory (LASL); and responsibility for the conduct of sample analysis, report writing, etc., was assigned to the U. S. Naval Radiological Defense Laboratory (NRDL). The Project Officer was supplied from the NRDL technical staff. H. F. Plank, as technical advisor to the project officer, was responsible for the conduct of the LASL portion, E. H. Fleming acted in a similar capacity for the UCRL portion and N. E. Ballou and T. Triffet are responsible for the NRDL portion.

SAN BRUNO FRC

ACKNOWLEDGMENTS

The authors wish to acknowledge the vital contributions made to the Project, in both the field and the laboratory, by members of the Los Alamos Scientific Laboratory, the University of California Radiation Laboratory, and the U.S. Naval Radiological Defense Laboratory.

Persons contributing invaluable aid included: G. Cowan, P. Guthals, and H. Plank from the Los Alamos Scientific Laboratory; R. Batzel, R. DaRosa, E. Fleming, R. Goeckerman, F. Momeyer, W. Nervik, P. Stevenson, and K. Street from the University of California Lawrence Radiation Laboratory; and J. Abriam, N. Ballou, L. Bunney, C. Carnahan, E. Freiling, M.G. Lai, D. Love, J. Mackin, M. Nuckolls, J. O'Connor, D. Sam, E. Scadden, E. Schuert, P. Strom, E. R. Tompkins, T. Triffet, H. Weiss, L. Werner and P. Zigman from the U.S. Naval Radiological Defense Laboratory.

SAN BRUNO FRC

TABLE OF CONTENTS

ABSTRACT	2
PREFACE	4
ACKNOWLEDGMENTS	5
CHAPTER 1. INTRODUCTION	11
1.1 Objectives	11
1.2 Background and Theory	11
1.2.1 Formation and Nature of Fallout Particles	14
1.2.2 Cloud Development	19
1.2.3 Transport and Distribution	20
1.2.4 Procedures for the Determination of Fallout Partition	23
1.2.5 Prior Estimates of Local Fallout	26
1.2.6 World Wide Fallout	28
1.2.7 Fractionation Effects (I): Observations at other Tests	30
1.2.8 Fractionation Effects (II): Relations among the R-Values for Several Radionuclides	32
1.3 Experimental Program	34
1.3.1 Outline of the Program	34
1.3.2 Rocket Sampling of Clouds	35
1.3.3 Aircraft Sampling of Clouds	36
1.3.4 Aircraft Sampling of Fallout	37
1.3.5 Selection of Radionuclides	39
CHAPTER 2. PROCEDURE	40
2.1 Shot Participation	40
2.2 Instrumentation	41
2.2.1 Rocket-Borne Cloud Sampler	41

SAN BRUNO FRC

[REDACTED]

2.2.2 Aircraft-Borne Samplers 43

2.2.3 Discussion of Some Errors in Sampling 49

2.3 Description of Field Operations 50

 2.3.1 Meteorology 50

 2.3.2 Koa Event 54

 2.3.3 Walnut Event 57

 2.3.4 Oak Event 59

 2.3.5 Rocket Development Work 60

 2.3.6 Aircraft Samples 61

2.4 Particle Work 62

2.5 Sample Analysis and Radiochemical Procedures 64

2.6 Data Reduction 68

CHAPTER 3. RESULTS AND DISCUSSION 69

 3.1 Discussion and Interpretation of the Data 69

 3.1.1 Cloud Data 69

 3.1.2 Fallout Data 78

 3.1.3 Combined Cloud and Fallout 84

 3.2 Data Reliability 86

 3.2.1 Cross Contamination of Koa Samples 86

 3.2.2 Accuracy of Radiochemistry 87

 3.2.3 Reliability of Sampling 87

 3.3 Comparison with Results of Previous Tests 88

 3.4 Effectiveness of Instrumentation 90

CHAPTER 4. CONCLUSIONS AND RECOMMENDATIONS 92

 4.1 Conclusions 92

 4.2 Recommendations 93

[REDACTED]

[REDACTED]

APPENDIX A. ROCKET DEVELOPMENT 94

APPENDIX B. RADIOCHEMICAL DATA TABLES 108

APPENDIX C. PARTICLE DATA AND CHARACTERISTICS, SHOT KOA . 116

APPENDIX D. METEOROLOGICAL DATA TABLES 128

APPENDIX E. DERIVATION OF FORMULA FOR % Mo IN CLOUD . . . 135

REFERENCES 137

FIGURES

2.1 Air-Sampling Rocket 44

2.2 Diffuser Section of Air-Sampling Rocket 44

2.3 Battery of Rockets Ready for Firing 45

2.4 B-57 Gross Particulate Sampler 45

2.5 Intake and Filter Section, B-57 Gas Sampler 47

2.6 Pumps and Gas Bottles, B-57 Gas Samplers 47

2.7 Filter Foil Installed on Top of B-50 48

2.8 B-50 Filter Screen 48

2.9 Plan View Wind Velocity Hodograph, Shot Koa 52

2.10 Plan View Wind Velocity Hodograph, Shot Walnut 53

2.11 Plan View Wind Velocity Hodograph, Shot Oak 55

3.1 Particle-Gas Fission Ratios as a Function of Time for Samples from the Light and Variable Wind Layer 71

3.2 Fraction of Total Sr⁹⁰ Formed Which Remains Aloft at Various Times 72

3.3 Fraction of Total Cs¹³⁷ Formed Which Remains Aloft at Various Times 73

3.4 Mo⁹⁹ : Kr⁸⁸ Ratios for the First Four Hours 79

A.1 Diagram to Illustrate Rocket Programming 100

A.2 Schematic View of Rocket Nose Section 101

C.1 Particle Fall Rate Distribution Curves for Height Line Samples, Shot Koa: Samples Massive L1, L2, L3 and L4 119

C.2 Particle Fall Rate Distribution and Specific Activity Curves for Height Line Samples, Shot Koa: Sample Massive L5 120

C.3 Particle Fall Rate Distribution and Specific Activity Curves for Height Line Samples, Shot Koa: Wilson Special Sample . . . 120

SAN BRUNO FRC

C.4	Particle Fall Rate Distribution and Specific Activity Curves for Cloud Samples, Shot Koa: Sample 502, Coarse . . .	121
C.5	Particle Fall Rate Distribution and Specific Activity Curves for Cloud Samples, Shot Koa: Sample 502, Fine . . .	121
C.6	Particle Fall Rate Distribution and Specific Activity Curves for Cloud Samples, Shot Koa: Sample 500, Coarse . . .	122
C.7	Particle Fall Rate Distribution and Specific Activity Curves for Cloud Samples, Shot Koa: Sample 500, Fine . . .	122
C.8	Particle Fall Rate Distribution and Specific Activity Curves for Cloud Samples, Shot Koa: Sample 977, Coarse . . .	123
C.9	Particle Fall Rate Distribution and Specific Activity Curves for Cloud Samples, Shot Koa: Sample 977, Fine . . .	123
C.10	Particle Size Distribution Curves for Height Line Samples, Shot Koa: Samples Massive L1 and Massive L4 . . .	124
C.11	Particle Size Distribution Curves for Cloud Samples, Shot Koa: Samples 502, Coarse, and 502, Fine . . .	125
C.12	Particle Size Distribution Curves for Cloud Samples, Shot Koa: Samples 500, Coarse, and 500, Fine . . .	126
C.13	Particle Size Distribution Curves for Cloud Samples, Shot Koa: Samples 977, Coarse, and 977, Fine . . .	127

TABLES

2.1	Device Information . . .	40
2.2	Cloud Altitude Data . . .	51
3.1	Particle-Gas Fission Ratios and R-Values for Samples from Light and Variable Wind Layer . . .	74
3.2	Fractions of Nuclides Left in Cloud after One Day . . .	75
3.3	Sr ⁹⁰ and Cs ¹³⁷ R-Values vs Altitude . . .	77
3.4	Mo ⁹⁹ : Kr ⁸⁸ , Kr ⁸⁸ : Kr ⁸⁵ Ratios for First Four Hours . . .	80
3.5	Data on Nuclides in Fallout . . .	83
3.6	Comparison of Airborne and Deposited Fractions . . .	84
3.7	Enrichment Factors in Fallout . . .	85
3.8	DELETED Analyses on Koa Cloud Samples . . .	87
3.9	Cloud Data, Operation Redwing . . .	89
3.10	Fractionation-Corrected R-Values for Redwing . . .	90
B.1	Radiochemical Data, Koa Particulate Samples . . .	110
B.2	Radiochemical Data, Koa Gas Samples . . .	111
B.3	Radiochemical Data, Walnut Particulate Samples . . .	112
B.4	Radiochemical Data, Walnut Gas Samples . . .	113
B.5	Radiochemical Data, Oak Particulate Samples . . .	114
B.6	Radiochemical Data, Oak Gas Samples . . .	115

[REDACTED]

C.1	List of Samples Measured, Shot Koa	116
C.2	Particle Classification and Size Measurements, Shot Koa	118
D.1	Winds Aloft Data, Shot Koa	129
D.2	Winds Aloft Data, Shot Walnut	130
D.3	Winds Aloft Data, Shot Oak	131
D.4	Atmospheric Temperature Data, Shot Koa	132
D.5	Atmospheric Temperature Data, Shot Walnut	133
D.6	Atmospheric Temperature Data, Shot Oak	134

SAN BRUNO FRC

CHAPTER 1

INTRODUCTION

1.1 OBJECTIVES

The general objective of the project was to estimate, from analytical data on cloud samples, the relative distribution of certain radionuclides between the local and world-wide fallout formed by megaton-range detonations on land and water surfaces.

Specific objectives were to: (1) obtain airborne particle and gas samples by rocket and aircraft sampling techniques; (2) determine the distribution of radionuclides between two groups of particles which differed from one another in their falling rates in air and which could be considered representative of local and world wide fallout; (3) attempt to determine an early-time distribution of radionuclides and particles between the upper and lower halves of the cloud and radially outward from the cloud axis; (4) estimate the extent of separation of fallout from gaseous fission products by fission determinations on gas and particle samples collected coincidentally near the top of the cloud at various times following the shots.

SAN BRUNO FRC

1.2 BACKGROUND AND THEORY

Data on the geographical distribution of fallout are particularly needed to assess the global hazards associated with the testing of nuclear weapons,

[REDACTED]

but they are also important for an appraisal of the effects of nuclear weapons used in warfare.

It has been recognized since the earliest weapons tests that a substantial portion of the radionuclides formed in a nuclear detonation are deposited throughout the world, thereby becoming available for general biological assimilation. The total fallout is usually considered as being divided into two classes, designated as local and world-wide fallout. In a general way, local fallout is thought of as consisting of relatively large particles, which reach the earth's surface in a few hours, whereas world wide fallout is composed of finely-divided material which may remain suspended in the atmosphere for months or years and be deposited at long distances from the source. A more precise differentiation is needed for specific situations, one of the most important considerations being the location of the detonation site in relation to world centers of population. For explosions at the Pacific Proving Grounds, the boundary between the two classes has been chosen at a particle falling velocity of 3 inches per second; material settling out more slowly than this is likely to be transported beyond the ocean areas and deposited in inhabited regions. SAN BRUNO ERC

The ratio of local to world-wide fallout is governed by the size distribution of the particles in the nuclear cloud which act as collectors for the radioactive fission-product atoms. If many large particles with fast falling

[REDACTED]

rates are present, as is the case for surface or underground shots where the fireball contacts the ground, the local fallout will be large. Local fallout can be expected to decrease as the detonation height increases and become a negligible quantity for an air burst high above the ground.

Numerous estimates of local fallout have been prepared at previous Operations, mainly from analyses of radiation intensity data obtained in aerial and surface monitoring surveys. However, the uncertainties in converting from dose rate measurements to fission products deposited per unit area are so great that the results cannot be regarded with a great deal of confidence. More reliable values are evidently needed and in planning for Operation HARDTACK, the AEC examined possible ways of obtaining such information (Reference 1). After consideration of the difficulties inherent in additional refinement of surface measurement techniques, this approach was abandoned. An alternative program based on further development of existing cloud sampling procedures was formulated (Reference 2) and this culminated in Project 2.8.

A knowledge of fallout partition and how it is influenced by shot environment may contribute to reduction in world-wide fallout at future tests and to a better understanding of the military implications of local fallout. It will also assist in extrapolation to previously untried shot conditions and yields.

SAN BRUNO FRC

1.2.1 Formation and Nature of Fallout Particles. When a surface burst is detonated, great quantities of the adjacent environment are swept up and mixed with the incandescent air in the fireball. There is sufficient thermal energy in the hot gas to completely vaporize all the material in the immediate vicinity, but the flow of heat into a massive object, such as a shot tower, shield or coral rock, will be comparatively slow even with a high temperature gradient. Consequently, the interior portions of large structures in the neighborhood may not receive enough heat to evaporate and will be melted only. Later, when the fireball has risen above the surface, the material carried into it by the vertical air currents around ground zero will not be heated to the melting point. As a result, the fireball in its later stages will contain the environmental components as a mixture of solid particles, molten drops and vapor. The extraneous material in the Pacific shots will consist of coral and ocean water salts plus the components of the device, shield, and tower or barge.

The preponderance of oxygen and of the environmental material in the fireball is of outstanding importance in the formation of the fallout particles. As the hot air cools through the range 3500-1000 K^o, it becomes saturated with respect to the vaporized constituents and they condense out as an aggregate of liquid drops, most of which are very small (Reference 3) (References 4 and 5). These are mixed with the larger drops formed by

SAN BRUNO ERG

fusion and with solid particles.

The radionuclide atoms present will collide frequently with oxygen atoms or molecules and, since the majority of them are electron donors, metallic oxide molecules will be formed which become thermodynamically stable as the temperature falls. The oxide molecules, or free radionuclide atoms, also have frequent collisions with the liquid drops of environmental material (silica, alumina, iron oxide or calcium oxide) and these collisions may be inelastic since in some cases the incoming molecules will be held by strong attractive forces. The radioactive oxide molecules which condense at the liquid surface will spread into the interior of the drops and become more or less uniformly distributed throughout. Later, after the liquid drops have frozen, the incoming radionuclide molecules may be held by surface forces.

Another way in which the radionuclide molecules may become associated with the environmental material is by participation in the structure of the cluster embryos which are the precursors of the liquid drops (References 4 and 6).

Due to the very low concentrations of the radionuclide oxide molecules, collisions with one another will be relatively infrequent and it appears that the aggregation of enough molecules of this type to form a drop or crystal will be a rare event, if it occurs at all.

SAN BRUNO FRC

[REDACTED]

The isobaric radionuclide chains formed in the explosion are known to be distributed on a mass scale in a way generally similar to the products of asymmetric fission of U^{235} by thermal neutrons, but with some important differences. The experimental yield curve for slow neutron fission has a broad minimum for mass numbers approximately one-half that of the original nucleus and maxima on either side at mass numbers in the neighborhood of 95 and 139 (Reference 7). Comparing the chain yields for megaton-range detonations with this curve, it is noted that there is a small drop in the peak yields accompanied by an increase in the symmetric fission probability. The same nuclide distribution might be expected in the fallout material and this is found to be roughly true under certain conditions. In other cases, the chains formed initially separate from one another so that samples of fallout may differ in composition among themselves and also from the distribution curve characteristic for the event.

Fractionation is a term which has been applied to this phenomenon and it is used to signify an alteration in nuclide composition of some portion of the debris which renders it non-representative of the bomb products as a whole. The R-values, which are commonly used for reporting radiochemical data on cloud and fallout samples, are useful indices of fractionation. The R-value for any nuclide is defined as the ratio of the number of atoms

SAN BRUNO FRC

[REDACTED]

of this nuclide to the number of atoms of a reference substance (usually Mo^{99}) in the sample divided by the same ratio for the products of thermal neutron fission. Atoms which do not separate from the reference substance have R-values appropriate for the type of detonation, while enrichment or depletion are manifested by positive or negative deviations from the characteristic curve.

Knowledge of the causes and mechanism of fractionation is still largely incomplete at the present time. One effect that seems to be indicated by the available data may occur in the isobaric chains near mass numbers 90 and 140 which contain rare gas nuclides as prominent chain members. These have half-lives and independent fission yields such that they comprise a considerable fraction of the total chain yield during the period when the environmental material is condensing. If the rare gas atoms which collide with the liquid drops of environmental material are not held by strong forces, as appears probable, the particles formed at this stage will be depleted in the nuclide chains in question.

A variety of types of particles have been observed in the local fallout at previous test series (References 8,9,10,11, 12, 13). For land surface shots in the Pacific they have been mainly of three kinds: irregular grains, spherical solids and fragile agglomerated flakes. The grains were not, in general, uniform throughout, but consisted of layers or shells of calcium

SAN BRUNO ERC

[REDACTED]

oxide, calcium hydroxide and calcium carbonate formed by the decarbonation, hydration and recarbonation processes going on in the fireball and subsequently. The majority of them were white or transparent but some were yellow or brown. Many of the flaky aggregates were observed to disintegrate spontaneously into smaller particles within a few hours after collection.

In addition to these primary types, a fourth kind was noted consisting of small black spheres of calcium iron oxide ($2\text{CaO}\cdot\text{Fe}_2\text{O}_3$). These were usually observed adhering to the surfaces of the large grains but occasionally were found isolated (Reference 12).

For detonations over ocean surfaces the fallout collected consisted of droplets of salt slurry 50-300 microns in diameter. These contained about 80% salt, 18% water and 2% insoluble solids by volume. The major part of the radioactivity was found in the insoluble solids portion.

The fallout deposited at more distant points has not been as well characterized but is believed to be composed of minute spheres formed by condensation of the environmental material from the vapor plus a very fine, unfused dust swept up into the cloud from the area around the shot point (Reference 14).

The availability of the radioactivity in the fallout for assimilation into the biosphere depends to a large extent on its solubility in aqueous

SAN BRUNO FRC

media. Determination of the soluble fraction is therefore an important problem and solubility studies have been reported on fallout from several of the shots at Operations CASTLE and REDWING. For CASTLE fallout, it was found that the soluble fraction was strongly dependent on the detonation environment, being around 0.05 for land shots and 0.58-0.73 for shots fired from a barge (Reference 15). The solubility in seawater of the fallout from the reef shot Tewa, Operation REDWING, was investigated in two ways: by leaching of particles placed on top of a glass wool column and by centrifuging a suspension of the fallout material (Reference 13). The soluble fractions found by these two methods were 0.08 and 0.18, respectively. An ultrafiltration method was used for determining the solubility of fallout from the land shot, Zuni. About 25% of the total gamma activity and Np^{239} were soluble in seawater and 5% of the total gamma activity was soluble in rainwater.

1.2.2 Cloud Development. During the later stages of existence of the fireball, it is transformed into a vortex ring whose rotational velocity persists up to the maximum cloud altitude, at least for the larger shots. The vortex contains the fission products, environmental material and bomb components which were present in the fireball and is the site where the radioactive fallout particles are generated. The cloud continues to rise until its buoyancy is reduced to zero by adiabatic expansion, entrainment

[REDACTED]

of cold air and loss of energy in overcoming atmospheric drag (References 16, 17, 18). The diameter of the ring increases rapidly during the ascent and the cloud spreads out laterally to a large area as its upward velocity decreases. For smaller yields the cloud stops at the tropopause or below, but for megaton-range weapons the top may penetrate several thousand feet into the stratosphere. The time to maximum altitude is somewhat less than ten minutes.

A knowledge of the distribution of activity and particles within the stabilized cloud is needed for the establishment of a rational fallout model; however, the collection of a suitable set of samples which could be used to determine these quantities experimentally presents a formidable operational problem which has not yet been solved. Several distributions have been assumed in an effort to match the fallout patterns on the ground, but it is not known how closely these models correspond to the actual structure of the cloud. Considering the method of formation, it might perhaps be anticipated that the activity would be greatest in an anchoring ring centered on the axis of the cloud. Some evidence for this structure was obtained at Operation REDWING with rockets with telemetering ionization chambers (Reference 19).

1.2.3 Transport and Distribution. During the ascent of the nuclear cloud the particles present are acted on by body forces and by the vertical

SAN BRUNO FRG

currents in the rising air. Some of the large particles will be heavy enough so that they will have a net downward velocity even though the cloud as a whole is moving upward. They will contribute to the fallout in the immediate vicinity of ground zero (Reference 20).

Once the upward motion has ceased, the particles in the cloud will begin to settle out at rates determined by their density, dimensions and shapes and by the viscosity and density of the air (Reference 21). The terminal velocities for small spheres can be accurately calculated when the dependence of the drag coefficient on Reynold's number is known. Irregular or angular particles will fall more slowly than spheres of the same weight, but their velocities cannot be estimated as well due to uncertainty in the shape factors (Reference 22).

The particles which make up the local fallout follow trajectories to the surface governed by their fall rates and by the mean wind vector between their points of origin in the cloud and the ground level. Locations can be specified by reference to a surface coordinate system made up of height lines and size lines. The height lines are the loci of the points of arrival of all particles originating at given heights on the axis of the cloud. The size lines connect the arrival points of particles of the same size from different altitudes. Time and space variation of the winds will change the magnitude and direction of the mean wind vector, and vertical motions

SAN BRUNO ERC

[REDACTED]

in the atmosphere will alter the falling rates of the particles. Corrections for these effects can be made when adequate meteorological data is available.

The local fallout as defined here will be down in 4.5 days or less, leaving aloft an aggregate of particles ranging from about 25-micron diameter down to submicron size. For small shots the majority of this will be in the troposphere but for megaton-range yields a large proportion will be deposited in the stratosphere. Hence, in discussing worldwide fallout, it is desirable to consider it as subdivided into two classes identified as tropospheric, or intermediate, fallout and stratospheric, or delayed, fallout (Reference 23).

The material left in the troposphere is thought to remain aloft up to forty days and to circle the earth a few times before reaching ground level. It deposits in relatively narrow bands, centered on the detonation latitude, with little evidence of diffusion across the stable air barrier located in the troposphere north of the equator. It is probably brought down largely by the scavenging effect of rainfall or other precipitation (Reference 23).

Those particles which do not fall out within the first few weeks will remain suspended in the atmosphere for a prolonged period — a matter of around seven years on the average. This material originates exclusive-

SAN BRUNO FRC

ly in the stratosphere and the particle size, although not known, must be very small, probably less than 0.1 micron. It is distributed by the stratospheric winds in the east-west or west-east direction, and there is also thought to be a slow circulation toward the poles. Movement into the troposphere can take place by slow settling or by seasonal changes in the altitude of the tropopause. The exchange may be most prevalent at the break in the tropopause near the middle latitudes. Once transfer from the stratosphere is completed, the material will be deposited relatively quickly in the same manner as intermediate fallout (Reference 23).

1.2.4 Procedures for the Determination of Fallout Partition. The hazards of nuclear weapons testing are associated primarily with world-wide fallout, since local fallout can be controlled by selection of the test site and the proper winds aloft so that its area of deposition will be of minor consequence to the population of the world. Introduction of radionuclides, such as Sr^{90} , into the human environment via world-wide fallout has a potential effect on the whole population and their significance has been studied in great detail (Reference 24). As a result of these studies, it has been concluded that certain radionuclide levels at the earth's surface can be tolerated and that these levels can be maintained within acceptable limits by restrictions on the rate of nuclear testing. This is based on the concept that a condition of "equilibrium" is reached in the

[REDACTED]

stratosphere at which the rate of injection of radioactive bomb debris will be equal to the decay plus deposition rate. A concensus reached at the 1957 Congressional Committee hearings on fallout placed the permissible rate of testing at 2-10 MT per year (Reference 24). The validity of such numbers depends in large part on the reliability of experimental determinations of the fraction of the weapon appearing in global fallout.

This fraction has usually been estimated indirectly by measuring the fallout in the local area and subtraction from unity. The methods used for the determination of local fallout have involved measurement of gamma ray field contours or representative sampling of the material arriving at the surface of the earth (References 25 and 26). The total amount of radioactive debris in the fallout area may be calculated if the relation between dose rate and surface density of radioactive material is known. Similarly, samples representing a known area of the fallout field may be analyzed for amount of weapon debris and all such areas summed to give the total local fallout. A combination of fallout sampling and analysis plus gamma radiation measurements has also been used (Reference 26).

These procedures are subject to a number of difficulties and uncertainties, not only with regard to making adequate sample collections and radiation field measurements, but also in data interpretation. The establishment of accurate gamma contours requires an extensive and costly

SAN BRUNO FRC

[REDACTED]

field program since radiation intensity measurements must be made over areas up to tens of thousands of square miles. When the fallout is deposited mainly over the surface of the ocean, the original patterns are distorted continuously by settling of the particles and by ocean currents. The collection of samples at the earth's surface which are truly representative of the area sampled and free from collector bias presents problems which have not been fully solved to date.

Conversion of gamma intensity contour data to fraction of device requires knowledge of the relation of dose rate to fissions per unit area of the fallout field at one hour and of the gross radioactive decay rate. The decay rate varies with the device composition, environment and fractionation in a way which is not well understood. Some uncertainty will always be present in local fallout determinations by this method when fractionation exists to an unknown degree, even though all the other quantities are known accurately.

Another procedure for the determination of fallout partition was originated by the University of California Radiation Laboratory based on the supposition that certain of the rare gas fission products remain throughout their lifetimes as free atoms unattached to surfaces (Reference 26). If this is true, they will not be removed from the cloud by the falling particles and may be considered as representative of the number of fissions remain-

SAN BRUNO ERC

ing aloft for long periods.

In the application of this method, coincident samples of gas and particles are taken by an isokinetic collector during the first few hours of existence of the clouds. The nuclear aerosol is sucked through a filter to remove the suspended material and the particle-free gas is then pumped into a storage bottle. The number of fissions in the two samples is determined by analyzing the gas for 2.8-hour Kr^{88} and the solid for a representative nuclide such as Mo^{99} .

The ratio of sample fissions calculated from a bound nuclide to those from an unattached rare gas nuclide will give the fraction of the reference substance which is in the cloud at the time of sampling. At a very early time, before any appreciable fallout has taken place, this ratio should be one, but later it would be expected to decrease as the falling particles remove the bound fission products. Hence the fraction of the material in world-wide fallout may be determined if the time is known at which particles having a falling velocity of 3 inches per second leave the sampling region.

1.2.5 Prior Estimates of Local Fallout. Determinations of local fallout have been made at virtually all the nuclear weapons tests conducted by the United States. Estimates of the fraction of the radioactivity deposited locally have been made for Operations JANGLE (References 16, 23, 25,

SAN BRUNO FRC

[REDACTED]

27, 28), TUMBLER-SNAPPER (References 27, 16), UPSHOT-KNOTHOLE (References 16, 27), CASTLE (Reference 29, 30, 31, 32, 33), WIGWAM (Reference 34), TEAPOT (Reference 35), and REDWING (References 23, 36). A summary of values computed from gamma contours and/or area sampling covered a range from 0.2 to 0.6 (References 25, 26). Re-examination of the preliminary REDWING data by Tucker (Reference 37) gave higher figures in the range 0.65-0.70 for barge (water surface) shots and up to 0.85 for land surface shots.

Results by the UCRL cloud sampling method are also available from REDWING (Reference 26) for the ground shots Lacrosse, Mohawk, Zuni and Tewa (part land, part water), for the water surface shots Huron and Navajo, and the high altitude air burst, Cherokee. In the first three events the ratio of solid-to-gas fissions was as low as 0.04. Values for Tewa were not much less than one but this was probably due to the low sampling altitudes relative to cloud height. The ratios for the barge shots were greater than 0.6 in all cases. For Shot Cherokee the single sample measured gave a ratio of one. Interpretation of these figures in terms of fallout distribution indicates that 90-95% of the activity came down locally for the land shots, 15-50% for the water shots, and essentially none for the high altitude air burst.

On 5-7 March 1957 a symposium was held at the Rand Corporation

[REDACTED]

to summarize and evaluate work done on fallout partition up to that time (Reference 26). The conferees concluded that the best generalization which could be reached on the basis of the data presented was an equal distribution of radioactivity between world wide and local fallout for both land and water detonations in the megaton range.

1.2.6 World-wide Fallout. World-wide fallout has been of great concern to persons responsible for the conduct of weapons tests on account of the possible consequences attendant upon the global dispersal of radioactive substances. The dangers from external irradiation are generally believed to be of a minor nature, due to the low levels of activity involved, but the incorporation of nuclides into the human system through the usual biological channels introduces the possibility of long-term effects whose seriousness is not easily determined.

The local fallout from the tests at Eniwetok, as defined earlier, will settle out in the Pacific Ocean and hence will be of only indirect concern. However, the tropospheric and stratospheric fallout will come down over land areas. Careful consideration of the nuclides present in global fallout has indicated that Sr^{90} is the one to be most feared due to its possible accumulation in the human skeleton and subsequent long-term irradiation of the hematopoietic tissues (Reference 24). Consequently, a major part of the work done on world-wide fallout has been directed toward the esti-

SAN BRUNO FRC

mation of Sr^{90} . Measurements have been made to determine the existing levels at the earth's surface, the quantity stored in the stratosphere, and the deposition rate. Samples of fallout have been taken from the soil and vegetation, by gummed tape and pot-type collectors on the ground, and by air-filter samplers at the surface and in the troposphere and stratosphere (References 8, 23, 39, 40, 41, 42, 43, 44, 45).

Based on this work, it was estimated in the fall of 1956 that the Sr^{90} levels were about 22 mc/mi² in the midwestern section of the United States, 15-17 mc/mi² for similar latitudes elsewhere and perhaps 3-4 mc/mi² for the rest of the world (References 38, 39). The total amount in the stratospheric reservoir, if uniformly distributed over the area of the globe, would increase these figures by about 12 mc/mi². The deposition rate of the stored material was considered to be around 10% per annum. It was further estimated that if these levels were maintained for fifteen years the concentration in the human skeleton would be about 1% of the maximum permissible (Reference 24).

The quantity of radioactivity in the storage reservoir was estimated by summation of the contributions of all the bursts through Operation REDWING which have deposited debris in the stratosphere. The available fraction of the weapon was determined by subtracting the local and intermediate fallout from the total. The intermediate fallout is thought to

SAN BRUNO FRC

contain 1-5% of the weapon for megaton-range detonations (References 16, 46, 47). Determinations of this quantity by a world-wide network of stations for shots Mike and King of Operation IVY gave a figure of 2% (Reference 47).

Some data on Sr^{90} concentrations in the stratosphere has been obtained from filter samples collected on flights of the General Mills high-altitude balloons. This work was part of a continuing program for sampling the stratosphere along the 80th meridian (Reference 48),

1.2.7 Fractionation Effects (I): Observations at Other Tests. The occurrence of fractionation is manifested by differences in radiochemical composition, decay rate or energy spectra among various samples of fallout taken at different times or locations in the contaminated region. Observations of some degree of fractionation have been made at many different detonations. As expected, fission product nuclides such as Sr^{89} , Sr^{90} , Cs^{137} , or Ba^{140} , which have rare-gas ancestors with half-lives of a fraction of a minute or longer, are frequently found among the most severely fractionated products. The location of the burst is also an important factor. Separation of the nuclides from one another appears to be most pronounced in underground or surface shots (References 49, 50), generally less for a water surface (Reference 51) and still smaller for balloon, high tower and air detonations (References 51, 52). Relatively

SAN BRUNO ERC

in water samples collected from the ocean surface near the site of detonation

little fractionation was found for the one device detonated in deep water (Reference 34).

At Operation GREENHOUSE it was noted that the exponent of the beta decay curve increased from 0.95 to 1.3 with median particle size for samples taken from the clouds at Dog, Easy and Able shots. This indicates that the close-in particles are enriched in fast decaying components with respect to the more distant fallout (Reference 53).

For JANGLE surface shots, pronounced depletion of chains 89, 115, 111 and 140 referred to Mo^{99} was observed in comparing long-range with local fallout samples. Chains 144 and 95 were not fractionated. Still more extensive nuclide separation was found for the underground shot with all the above chains showing depletion in the crater area (Reference 53).

On Shot 6 at TUMBLER-SNAPPER the gross decay exponent decreased steadily with distance from ground zero up to seventy miles (Reference 53).

Radiochemical data from CASTLE Brave showed fractionation of Sr^{90} and Ba^{140} with respect to Mo^{99} , but none for Ce^{144} (Reference 53).

In the land Shots Zuni and Tewa of Operation REDWING, depletion of Cs^{137} , Sr^{90} , and Te^{132} was found in the close-in fallout with maximum factors of 100, 13 and 7 (Reference 54). These depletion factors became smaller with increasing distance from the shot point. Fractionation of the

fallout from the barge shots Flathead and Navajo was much less and variations in abundance were not greater than a factor of two (Reference 54). Analytical data on cloud samples from these four events corroborated the fallout results (References 50 and 51).

Some radiochemical analyses have been performed on particles of different sizes from certain balloon shots (Reference 52). In Boltzmann of Operation PLUMBBOB, both the $\text{Sr}^{89} : \text{Mo}^{99}$ and $\text{Sr}^{90} : \text{Mo}^{99}$ ratios were a factor of two greater in 22-micron particles than in 137-micron particles. Enrichment of Sr^{89} was also found in two other balloon shots, Hood and Wilson.

1.2.8 Fractionation Effects (II): Relations among the R-Values for Several Radionuclides. As noted above, some scattered observations on fractionation were reported from the earlier tests, but it was not until Operation REDWING that enough data became available to investigate the separation of various nuclides from one another in any detail. At event Tewa of this operation, six particle samples were collected from different locations in the cloud and subsequently analyzed for around thirty nuclides. From this work, relations among the R-values for the products became apparent which seem to be of significance for understanding the fallout formation process (Reference 55). The R-values for the substances studied (normalized to give unit intercept on the axis of ordinates) were plotted

SAN BRUNO FRC

against the R-value for Eu^{156} and a series of straight lines resulted with slopes ranging from positive to negative values. Positive slopes indicated a simultaneous enrichment of the cloud particles in europium and the product nuclide, whereas negative slopes showed that as the particles became richer in europium they were more and more depleted in the product nuclide. Products having rare-gas and alkali metal precursors had the steepest negative slopes while U, Np and Pb had small negative slopes. The more refractory oxide elements Nd, Be, Zr and Nb had positive slopes and those elements such as Ca, which showed no fractionation with respect to europium, had infinite positive slopes. The results are consistent with the view that these products having rare-gas or alkali metal ancestors at the time of condensation will concentrate in the smaller particles which have a larger surface-to-volume ratio.

Similar relationships have been found for several high yield air bursts using Ba^{140} as the secondary reference nuclide and Mo^{99} as the primary reference nuclide (the primary reference nuclide is the substance used as reference in calculating the R-values; the secondary reference nuclide is the substance used as abscissa in the R-value plots). In this reference system, Ag^{111} , U^{237} , Cd^{115} , Cs^{136} , Np^{239} , Y^{91} , and Sr^{89} had approximately unit positive slopes while Zr^{97} , Ce^{144} , Pu^{239} and the rare earths had average negative slopes of 1.5. For these shots there was

SAN BRUNO ERG

[REDACTED]

evidence that the nuclides in the larger particles (3-12 μ) were fractionated, but those in particles smaller than 1 μ were not (Reference 56). TM

This method of data analysis has been shown to be valid regardless of the secondary reference nuclide, the primary reference nuclide and the reference event (Reference 6). TM

1.3 EXPERIMENTAL PROGRAM

1.3.1 Outline of the Program. The foregoing discussion indicates that further progress in the development of a realistic fallout model will require an improved knowledge of the structure of nuclear clouds with respect to the vertical and radial distribution of particle size and radioactivity within the mushroom. Quantitative data on the activity associated with particles in different size groups is also needed for estimation of the partition of the weapon between local and world-wide fallout. Project 2.8 was established to attempt to obtain such information from certain shots at Operation HARDTACK. It was planned to explore the cloud structure by means of air sampling rockets and to use both the rocket samples and also aircraft samples collected from the cloud with the UCRL coincident sampler for determination of the fallout partition. Other aircraft flying at 1000 feet were scheduled to collect fallout samples to be used for the determination of the effect of particle size on fractionation and for corroboration

SAN BRUNO ERG

[REDACTED]

of the radionuclide composition of local fallout as determined from the rocket samples. The influence of the environment on fallout partition was to be investigated by participation in events over land and water surfaces.

1.3.2 Rocket Sampling of Clouds. Experimental determination of the distribution of activity within the cloud requires the collection of a group of samples at different vertical distances along paths nearly parallel to the axis and at various radial distances. The almost-vertical flight path requirement necessitates the use of sample collectors which are propelled by rockets.

The rockets used by the project had a rather complex structure (see Chapter 2) but from the standpoint of particle collection their important features were the sampling head and the electronic programmer. The sampling head was designed to separate the particles collected into two groups having falling rates corresponding to local and world-wide fallout as already defined. The separation was to be attained by the action of aerodynamic forces in the sampler similar in effect to those experienced by particles falling through the atmosphere in the gravitational field of the earth. The function of the electronic programmer was to open the head at predetermined positions in the flight path so that samples could be collected from different portions of the cloud.

SAN BRUNO FRC

It was planned to fire a total of eighteen rockets on each shot at about H / 10 minutes from launching platforms spaced at various distances from ground zero. Two rockets were to be fired along each trajectory, one programmed to collect a sample from the base to the top of the debris and the other to collect from the top half of the cloud only.

1.3.3 Aircraft Sampling of Clouds. A condition necessary for use of the gas-particle sampling technique for the determination of device partition is that the samples be collected from a region which is losing material by fallout but not receiving particles from any other section of the cloud. The portions of the cloud which are suitable for this type of sampling are dependent on the wind structure existing at the time of burst. For one type of structure which occurs fairly frequently at the proving grounds, the top and bottom parts of the cloud are blown off rapidly in different directions leaving a layer approximately one mile thick that experiences only light and variable winds. Hence this stratum, which is located between 50,000 and 60,000 feet, will soon be isolated from the rest of the cloud and may remain fairly closely over ground zero for a day or more. It is called the "light and variable wind layer" and is satisfactory for coincident sampling since it can not receive fallout from higher cloud levels.

SAN BRUNO ERG

[REDACTED]

In cases where the stratum is not well defined, sample collections can be made from the top of the cloud provided this can be reached and followed by the sampling aircraft or from a location selected to minimize the feed-in of fallout from higher altitudes.

The theory of this technique has been discussed under section 1.2.4 and the sampling equipment is described in Chapter 2. The operation plan was to fly through the light and variable layer at several intervals between $H \pm 2$ and $H \pm 24$ hours with B57D aircraft equipped both with the coincident samplers and with wing tank particle collectors. The coincident samples were to be analyzed for Kr^{88} and Mo^{99} to determine the fallout partition (see 1.2.4) and the wing tank samples for ten radionuclides to investigate fractionation with particle size.

1.3.4 Aircraft Sampling of Fallout. The fallout sampling part of the program was intended to provide information supplementary to that obtained from the rocket and aircraft cloud sampling experiments. WB-50 aircraft were scheduled to fly at an altitude of 1000 feet and to collect fallout at various times between $H \pm 4$ and $H \pm 24$ hours along height lines which would correspond to the cloud level (ca 55,000 feet) sampled by the B57D's. Since the cloud is an extended source of fallout, the term "height-line sampling", as used here, signifies the sampling of a band of material centered on the geometrical height line and having a band width approxi-

SAN BRUNO ERG

[REDACTED]

mately equal to the diameter of the cloud.

The wind structure described in the preceding section on the formation of the light and variable layer also leads to isolation of the 55,000 foot height line along the eastern periphery of the fallout curtain. This situation is advantageous for height line sampling since the aircraft may proceed westward from a position east of the fallout area and collect the first fallout encountered. The samples should contain 55,000-foot fallout alone, uncontaminated by material from the rest of the cloud.

Other types of wind structure will probably not be as favorable for height line sampling and the fallout collected is likely to contain particles originating from different levels in the cloud.

As one proceeds outward from ground zero along a height line, the particle size of the fallout decreases and the time of arrival increases. However, low altitude sampling at a given location should provide a sample containing particles of relatively uniform size.* Hence, by making a series of collections along a height line at different distances from the shot point, advantage can be taken of particle size separation by natural fallout processes. The WB-50 operations were arranged to utilize this situation to obtain a set of samples suitable for an investigation of size-dependent

* Used synonymously with falling rate.

SAN BRUNO FRC

[REDACTED]

[REDACTED]

properties.

It was planned to use the radiochemical data from these samples to corroborate the composition of local fallout as determined from the rocket experiments, to investigate fractionation with particle size, and to compare the composition of local fallout with world wide fallout. It can not be used for determination of device partition since the sample will not represent a determinate fraction of local fallout.

1.3.5 Selection of Radionuclides. The radionuclides chosen for determination from the particle samples were those of greatest concern in world-wide fallout, namely Sr^{90} and Cs^{137} , plus a sufficient number of others to provide basic data for further investigation of fractionation. In the latter category were Sr^{89} , Y^{91} , Mo^{99} , Cs^{136} , Ce^{144} , Eu^{156} and U^{237} . The members of this group existed in a variety of forms, ranging from gaseous to relatively non-volatile species, during the period of condensation from the fireball. Ca^{45} was determined in conjunction with elemental analyses for Ca and Na to help in tracing the behaviour of the environmental material which forms the major part of the fallout particles.

Analyses for I^{131} , which were tentatively planned originally, were not carried out due to the limited analytical personnel available, the uncertainties of sample collection for this nuclide and the relatively lesser interest in its ultimate fate.

SAN BRUN

CHAPTER II

PROCEDURE

2.1 SHOT PARTICIPATION

The project initially planned to participate in Shots Koa, a megaton-range land-surface burst, and Walnut, a ~~DELETED~~ water-surface burst. Due to apparent contamination of the Koa cloud samples by debris from Shot Fir, participation was later extended to include Shot Oak, a high-yield water-land burst fired over the lagoon reef. Important device information is given in Table 2.1. The project rockets participated during Shots Koa and Walnut and were also fired during Cactus and Yellowwood for system check and nose cone recovery practice. Aircraft were flown during Koa, Walnut and Oak.

TABLE 2.1

	<u>DEVICE INFORMATION</u>		
	<u>KOA</u>	<u>WALNUT</u>	<u>OAK</u>
Total Yield, Mt.:	1.31 / 0.08	DELETED	8.9 / 0.6
Fission Yield, Mt.:	DELETED	DELETED	DELETED
Location	Site Gene	Near Site Janet	4 miles south of Site Alice
Shot time	0630 M	0630 M	0730 M
	13 May 1958	15 June 1958	29 June 1958
Shot type	Land-Surface	Water-Surface; fired from a barge in deep water	Water-Land Surface; fired from an LCU anchored over the lagoon reef in 15 feet of water

2.2 INSTRUMENTATION

The instrumentation for this project falls into two general classes: rocket-borne and aircraft-borne cloud samplers. Two types of aircraft, B-57D's and WB-50's, were used.

2.2.1 Rocket-Borne Cloud Sampler. The rocket, a 20 foot long unit, consisted of an air-sampling nose section, a two-stage propulsion unit and various items of auxiliary equipment (Reference 57).

The air-sampling diffuser of the nose section was 36 inches long from the intake orifice to the filter. An additional 32 inches of length behind the filter was occupied by exhaust ports and auxiliary equipment. The extreme forward part of the rocket was a conical section 5 inches long which sealed the intake orifice prior to the time when sampling was begun. The orifice of the diffuser was 2 inches in diameter and the filter was 8-1/2 inches in diameter. An expansion from 2 inches to 8-1/2 inches in diameter in a length of 36 inches gave an expansion angle of 10 degrees, the maximum at which the flow would not separate from the diffuser walls. The filter was an 8 inch circle of matted cellulose fiber coated with stearic acid to help retain the particles. It was supported by a wire retaining screen. The inside wall of the diffuser was in the form of a revolved segment of a circle 250 inches in radius and was parallel to the axis of the rocket at the orifice. Particles entering the sampling section were decelerated from about twice the sonic

SAN BRUNO ERC

~~SECRET~~

velocity to subsonic by passage through a shock front which formed near the throat of the diffuser. Following this, they were subjected to a force field of such a nature that the smaller particles were impelled toward peripheral areas of the collecting filter to a greater extent than the larger particles. The diffuser was designed to effect a resolution of particles having average settling rates greater or less than 3 in./sec. in the normal atmosphere (Reference 57).

A light skin was wrapped around the outside of the diffuser to fair up the external shape of the nose cone.

The propulsion section contained primary and sustainer motors, both of which were solid-fuel units about 6 inches in diameter with burning times of 6 seconds. The sustainer motor was ignited shortly before the start of sampling and provided sufficient thrust to maintain the rocket speed at about Mach 2 during passage through the cloud.

Items of auxiliary equipment included explosive squibs, electronic timing circuitry, a parachute system, a closure system for the sampling section, a radio beacon and a dye marker. Foamed plastic inserts were fitted into the nose sections to provide additional buoyancy.

The explosive squibs were used to remove the conical nose tip, thereby opening the sampling orifice, and to jettison the propulsion unit. The electronic timing circuitry initiated the opening of the orifice, disconnection of

[REDACTED]

the propulsion unit, ejection of the parachute, closure of the sampling section and activation of the radio beacon. The parachute system consisted of a pilot chute, a pilot chute shroud cutter and the main canopy. The pilot chute was withdrawn from its compartment when the propulsion section was jettisoned, but remained attached by shrouds to the nose section until the latter had slowed down to a speed which would not cause damage to the main canopy. At this time the shrouds were cut and the main canopy was withdrawn from the nose section by the pilot chute shrouds, which were attached to a bag containing the large parachute. The front closure of the sampling unit, made by a ball joint, and the aft closure, consisting of a cone and "O-ring" seal, were closed after sampling. The radio beacon was activated at launch time so that search craft equipped with radio direction finders could locate the nose sections.

Figure 2.1 shows a complete rocket on a launcher. Part A is the primary motor, Part B the sustainer motor, Part C the parachute compartment, Part D the electronics compartment and Part E the air sampling nose section. Figure 2.2 gives the important dimensions of the diffuser and filter in the air sampling nose section. Figure 2.3 is a view of a battery of six rockets assembled for firing.

2.2.2 Aircraft-Borne Samplers. Three different types of equipment were

SAN BRUNO ERG

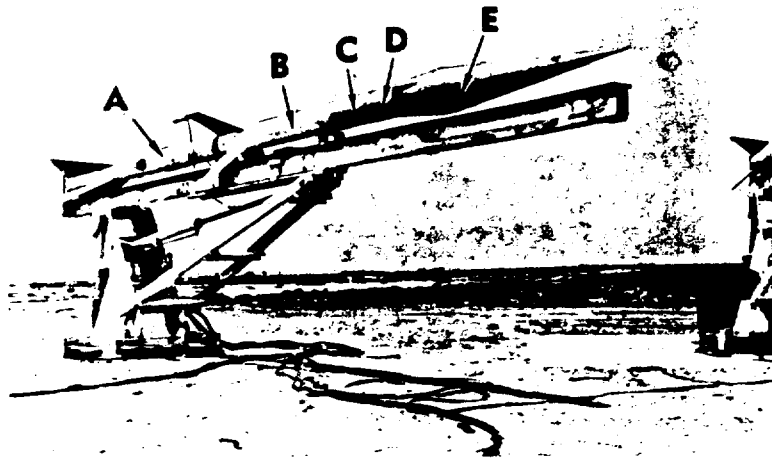

Figure 2.1 Air-Sampling Rocket

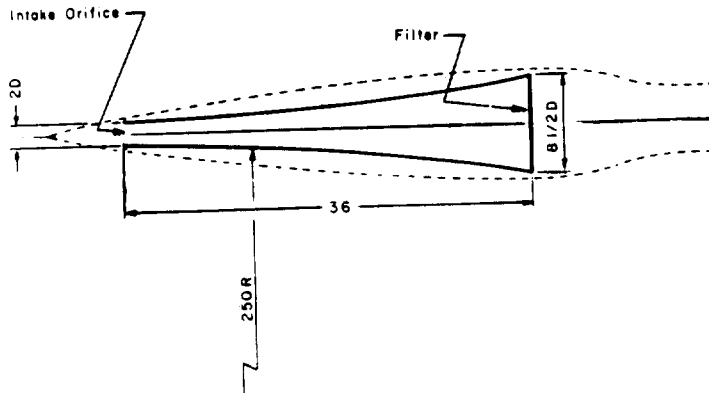

Figure 2.2 Diffuser Section of Air-Sampling Rocket

SAN BRUNO FRC

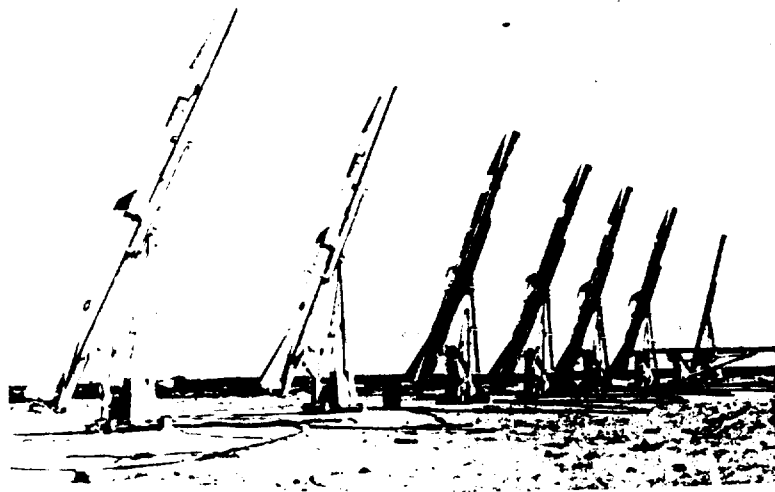

Figure 2.3 Battery of Rockets Ready for Firing



Figure 2.4 B-57 Gross Particulate Sampler

SAN BRUNO ITC

utilized to obtain the samples discussed in Sections 1.3.3 and 1.3.4. Units of the kind illustrated by Figure 2.4 were used for collection of the cloud particle samples needed for the radiochemical work. These samplers were stainless steel shells of parabolic shape fitted with intake butterfly valves which were open only during the sampling runs. They were installed at the forward end of both the right and left wing fuel tanks of the B-57D's. The particles were collected on a 24 inch filter paper which was supported by a retaining screen located near the aft end of the unit.

The coincident sampler was constructed in such a way that both the gas and particle samples would be taken from the same volume of the cloud. Air was drawn through a dessicant section and a filter section by a circulating pump and then forced under pressure into a sample bottle. Figure 2.5 shows the intake and dessicant-filter sections and Figure 2.6 is a photograph of the compressor pumps and gas bottles. These samplers were mounted on both sides of the B-57D fuselage toward the rear of the aircraft.

The WB-50's used for the height line fallout sampling were equipped with the AFOAT-1 standard E-1 filter assembly. Figure 2.7 is a view of a WB-50 with the filter foil installed on top, nearly over the rear scanner's position. Figure 2.8 shows the filter screen removed from the foil with a filter paper in one side. The foil was sealed by sliding doors in front and

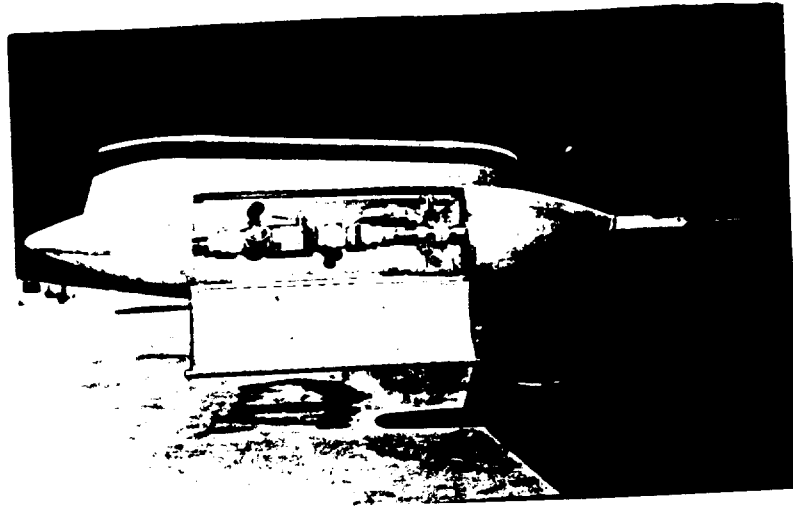

Figure 2.5 Intake and Filter Section, B-57 Gas Sampler

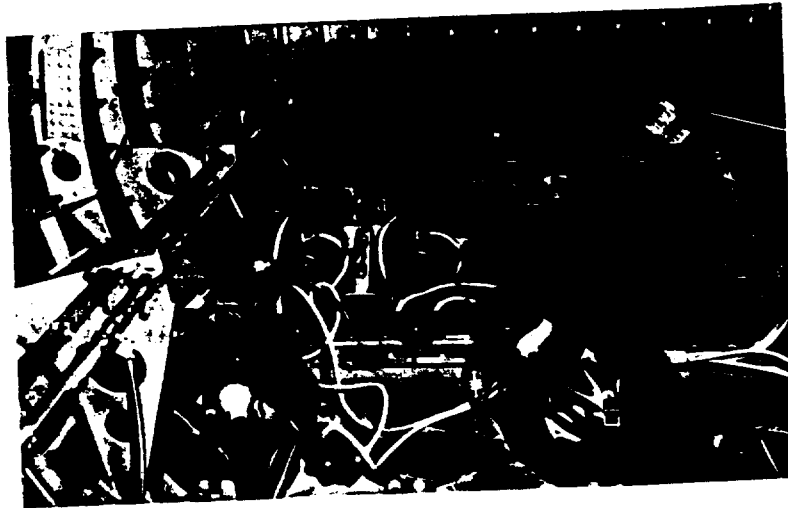

Figure 2.6 Pumps and Gas Bottles, B-57 Gas Samplers

SAN BRUNO ERG



Figure 2.7 Filter Foil Installed on Top of B-50

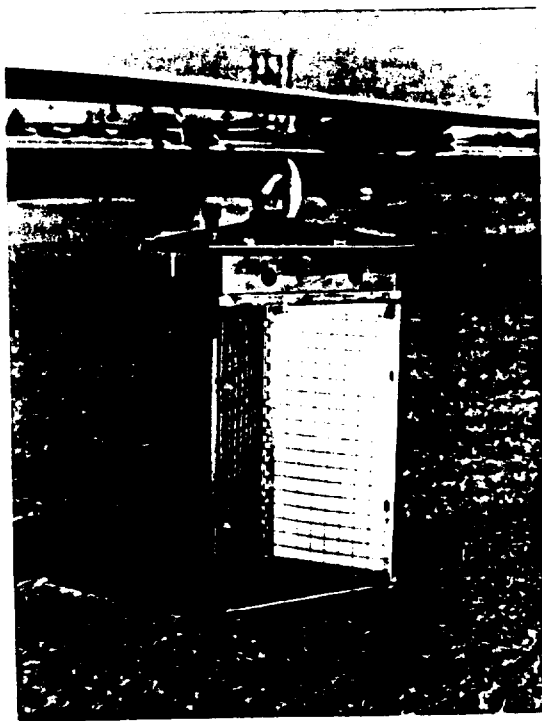

Figure 2.8 B-50 Filter Screen

SAN BRUNO ERG

back of the filter screen except during the sampling periods.

2.2.3 Discussion of Possible Errors in Sampling. Polydisperse aerosols contain an aggregate of particles whose sizes are arranged in accordance with a characteristic frequency distribution. When the aerosol is sampled under ideal conditions, the ratios of the numbers of particles in the various size ranges will be preserved unchanged in the collector. However, a departure from the initial size distribution may be encountered if the collecting device has a dimensional bias (non-isokinetic condition), or if some of the particles are broken up during the sampling operation.

Isokinetic sampling conditions will be achieved with a filtering device moving through the aerosol at subsonic speeds if the air velocity into the intake of the filter is identical with the flow rate past the outside. As used in Project 2.8, both the wing tank and coincident samplers were close to isokinetic since the velocity ratios were respectively 0.8 (or greater) and 0.7-0.9. However, in a few cases, the velocity ratios for the coincident units were much less, due to leaks in the line to the compressor pump (see Appendix B). The E-1 sampler used on the WB-50's was poor isokinetically, but this was considered to be immaterial for height line sampling where the particles in a given region should be fairly uniform in size. Samplers, such as the project rockets, which move at supersonic speed with respect to the aerosol are expected from aerodynamic theory to be unbiased.

SAN BRUNO FRC

[REDACTED]

In the rocket samplers some breakup of the fallout particles was thought to be likely in passing through the shock front in the diffuser throat. A series of experiments carried out by NRDL on the shock tube at the University of California Engineering Experiment Station indicated that coral fallout grains were not fractured by Mach 2 shock waves (Reference 58). Impact with the filter is another possible cause of particle breakup in all the sampling devices, but little or nothing is known about this effect.

2.3 DESCRIPTION OF FIELD OPERATIONS

2.3.1 Meteorology. It was indicated in section 1.3.3 that samples to be used for the determination of fallout partition by the UCRL method should be collected from the light and variable layer, if well defined, or from higher locations in the cloud. The cloud heights and wind structure in the upper atmosphere are therefore important characteristics to consider in devising operational plans. It is known from previous work that the clouds rise to a maximum altitude in the first few minutes and then settle back to a "stabilized" level. Based on height-yield curves derived from photographic data on earlier shots (Reference 21), it was estimated that the stabilized altitudes would be around 72,000 feet for Koa ~~DELETED~~ and 99,000 feet for Oak (Reference 59). The altitudes observed by project aircraft were considerably lower (Reference 60). A radar record for shot Koa indicated that the cloud rose to 72,000 feet at 5 minutes and then settled rapidly (Reference 61).

The light and variable layer existed for all the shots, being possibly

best defined for Koa where it circulated over the atoll for at least a day. For Koa and Walnut the altitude of the layer coincided quite closely with the top of the cloud, whereas for Oak it was some 20,000 feet below the top which was blown off rapidly by the strong easterly winds. Since the B-57D samples were taken from this stratum in each case, the criterion of sampling from a region which would not be receiving fallout from any other source was easily satisfied.

Some altitude data taken in part from the wind and temperature tables in Appendix E are given in the Table 2.2.

TABLE 2.2

	<u>Approximate Altitude in Feet</u>		
	<u>Koa</u>	<u>Walnut</u>	<u>Oak</u>
Tropopause	57,000	54,000	50,000
Light & Variable Layer	60,000 /	55,000	55,000
Cloud Top, Expected*	72,000	DELETED	99,000
Cloud Top, Observed	65,000	61,000	70,000 - 75,
Sampling Flights	60,300	56,500	56,300

* (Reference 59)

The suitability of the wind structures for fallout sampling along height lines can be most readily visualized by reference to the plan view, wind velocity hodographs at shot time which are reproduced in Figures 2.9, 2.10

SAN BRUNO

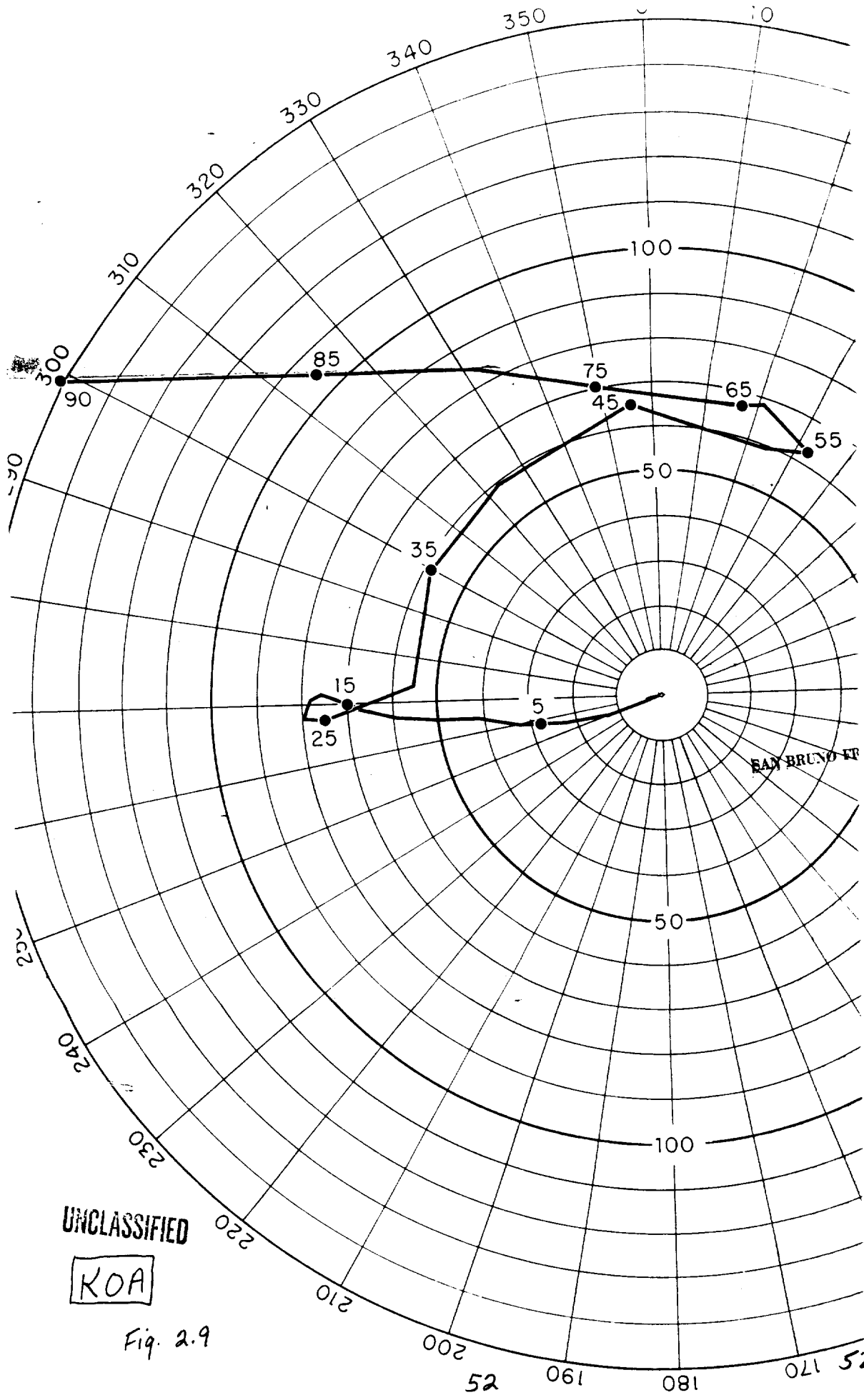

UNCLASSIFIED

KOA

Fig. 2.9

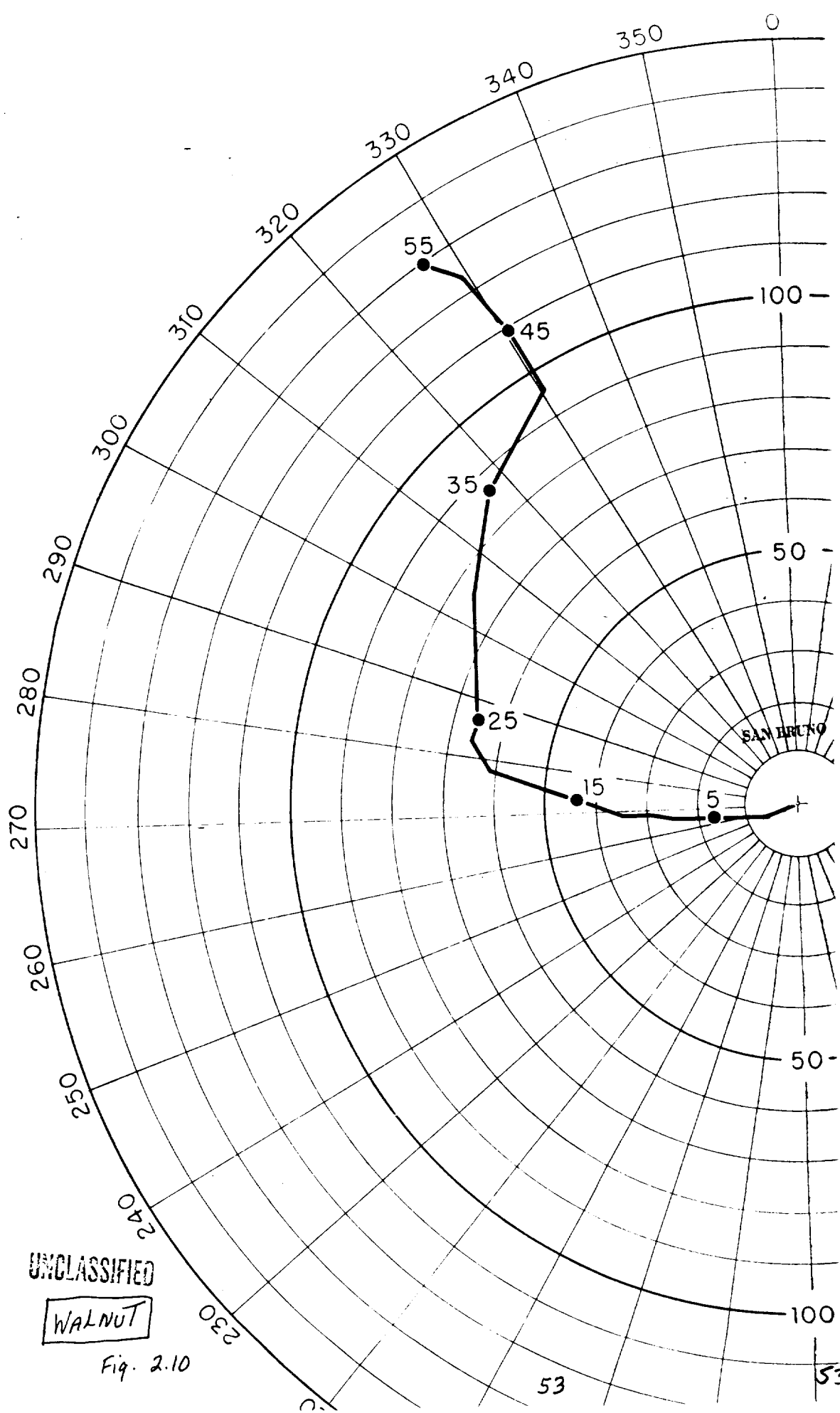

UNCLASSIFIED

WALNUT

Fig. 2.10

53

53

and 2.11. The Koa hodograph shows that for this event the winds were ideal for height line sampling since material falling from the light and variable layer would be clearly isolated from the rest of the fallout. On Walnut, an overlap of particles originating in the cloud at 40,000 feet and at higher levels would be anticipated. For Oak the samples collected at 1000 feet would contain material which came from several different elevations in the cloud.

2.3.2 Kea Event. No rocket samples were collected from Shot Koa.

In preshot planning it was intended that a salvo of 18 rockets would be fired into the cloud, 6 each from Sites Wilma, Sally and Mary. The firing line to Site Wilma failed on the day before the shot and could not be repaired before evacuation. Firing circuits to Sites Sally and Mary were intact at shot time and a firing signal was transmitted to these sites at H / 7 minutes, but no rockets fired. Failure appears to have been caused by the heavy current drain by several launcher orienting motors dropping the main power supply voltage to a point where it was insufficient to operate critical relays in the local launch programming equipment. Thereafter, launching operations were programmed so that only a single launcher motor would be operating at one time.

SAN BRUNO FI

Five samples were taken from the cloud by B-57D aircraft at 3-1/2, t, 8, 11 and 28 hours post-shot time (See Table B1). A flight scheduled for

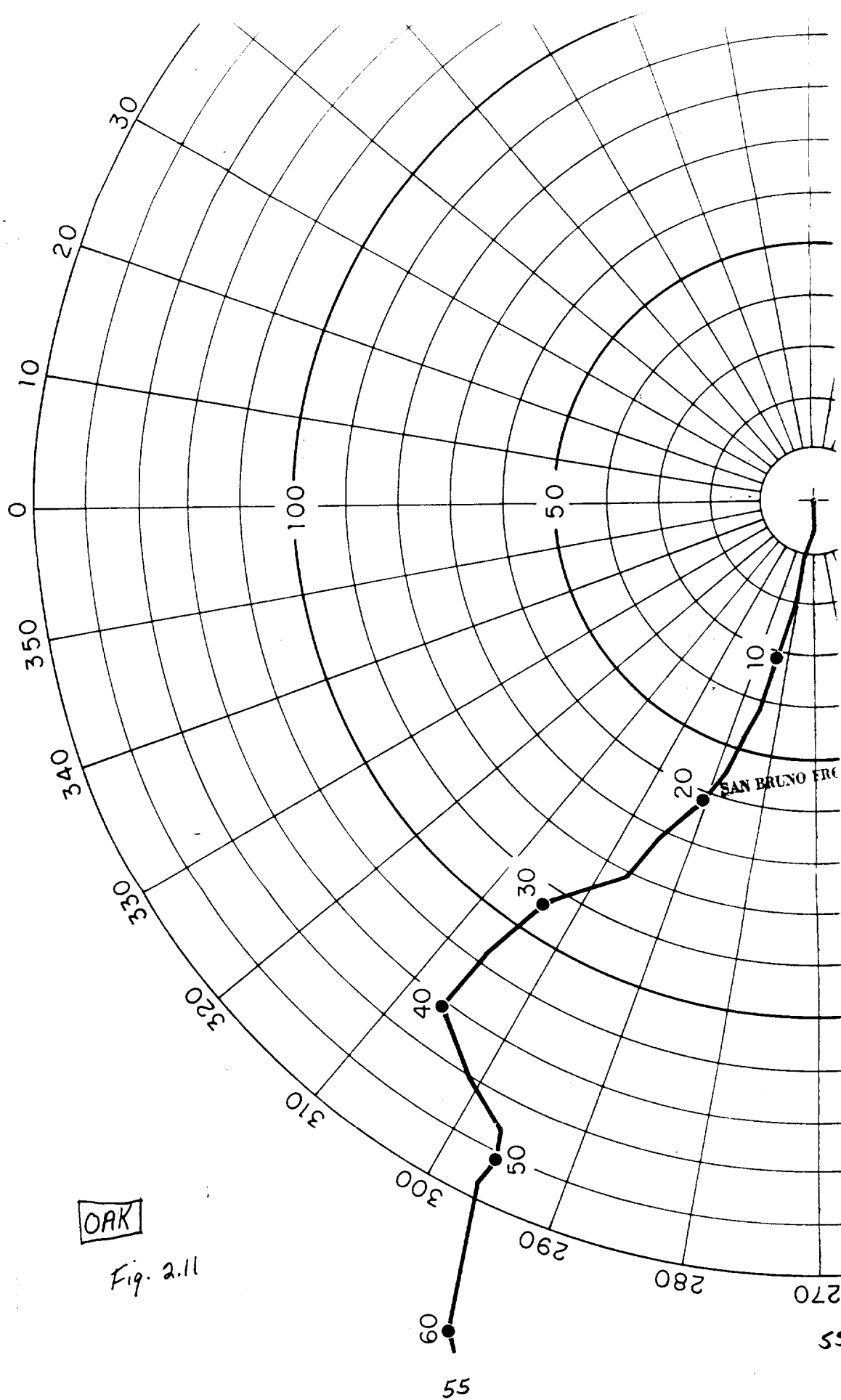

OAK

Fig. 2.11

[REDACTED]

13-14 hours had to be cancelled due to rain and atmospheric turbulence. The first four samples were collected in about 1/2 hour each and the last sample required 2-1/2 hours. The wing tank samplers functioned on each flight, but there were no gas samples on the last three runs due to a failure of the compressor pumps on the coincident sampling units.

Samples of material falling from the 60,000-foot layer were collected at an altitude of 1000 feet at 4, 6, 8, 10 and 12 hours after shot time by a WB-50 aircraft. The fallout was encountered on a bearing of 50-60 degrees at 28, 59, 88, 109 and 131 miles from ground zero. A second WB-50 collected one 1000-foot sample at H + 6 hours on a bearing of 20 degrees at 42 miles from ground zero. It is thought that this material came from about 45,000 feet. A third WB-50 mission was flown at 0700 the next day to 300 miles on bearing 58 degrees based on an extrapolation of the previous contacts. From there, the aircraft was directed to 225 miles, bearing 55 degrees, then to 200 miles, bearing 40 degrees, and finally to 400 miles, 60 degrees, but no fallout was encountered. The aircraft was released after 6 hours for a weather mission.

SAN BRU

Shot Fir, DELETED was fired at Bikini on the day preceding Koa and the clouds from the two bursts rose to approximately the same height (65,000 feet). On the day following Koa there was a deposition of fallout in the Eniwetok area and in the afternoon the gamma radiation background on

[REDACTED]

Site Elmer rose to 25-30 mr./hr. The Fallout Prediction Unit was not able to establish definitely the origin of this material, but felt that there was some reason to think that it had come from Shot Fir. After arrival of the Koa samples at LASL, a dispatch was received in the field indicating that the cloud, and possibly the fallout samples, were heavily contaminated with Fir debris. The nature of the evidence was not known at the time, but it was conjectured that sizable amounts of **DELETED** which was produced in large quantities in the Fir detonation, had been found in the Koa samples. Examination of the wind structures existing during the period of the Fir and Koa detonations indicated a possibility of some contamination of Koa fallout by Fir debris, but no mechanism was apparent that could lead to heavy contamination.

When the radiochemical data became available it was found that all the Koa cloud samples contained some material from Fir, but not enough to appreciably alter the significance of the results (see Chapter 3).

2.3.3 Walnut Event. It was planned to project a total of 10 rockets into the cloud, 4 each from Sites Mary and Sally and 2 from Site Wilma. The launchers on Mary were set for automatic positioning by blue-box signal, whereas on Sally and Wilma the quadrant elevations and azimuths were pre-set. After the shot the firing circuits to Sally and Wilma were intact, but the line to Mary was open. A firing signal was sent at H / 10 minutes and

SAN BRUNO FRC

[REDACTED]

the rockets on Sally and Wilma were launched, but the obscuring cloud cover prevented observation of their trajectories. The rockets on Mary did not launch and later inspection showed that one launcher was inoperative, one elevated without rotating and two elevated and rotated. Two nose cones from the Sally rockets were recovered by boat and the others were lost. The closures on the cones recovered were intact but water had leaked in. There was a small amount of activity in the water and on the filter and the filter sample was returned to the ZI for analysis. It was identified by the name Whiskey 6 (see Table B. 3).

6 samples were taken from the cloud at times between 1-1/2 hours and 26 hours post shot time (see Table B3). Both the wing tank and the coincident samplers were operative on each flight.

In preparing the height line flight program for this shot, it was intended that 1 WB-50 would collect 1000 foot samples at 4, 6, 8, 10 and 12 hours with a second WB-50 standing by on the ground to take over the mission, if necessary. No sampling flight was scheduled for D + 1 day. The first aircraft encountered fallout at H + 4 hours on a bearing of 320 degrees at a distance of 42 miles from surface zero and a sample was collected. Due to deposition of damp fallout material on the nose of the aircraft, a dose of 1.5 r. (read on an electronic integrating dosimeter) was accumulated at the bombardier's position during the sampling run. The

SAN BRUNO EBC

[REDACTED]

dose was continuing to rise at the rate of 50 mr. /min. and the radiological advisor aboard decided to discontinue the mission and return to base. The standby aircraft took off and was flown to a point on a bearing of 330 degrees at a distance of 120 miles from surface zero. At H + 8 hours the aircraft searched on course 225 degrees, but no fallout was encountered. At H + 10 hours the active fallout area was reentered at bearing 283 degrees, 140 miles from surface zero, and a sample taken. At H + 13 hours a third sample was collected at bearing 278 degrees, 150 miles from surface zero. This was a smaller sample, perhaps 10^{12} fissions, compared to 10^{15} for the first two.

2.3.4 Oak Event. There was no rocket participation during Shot Oak. Circumstances leading to the discontinuation of the rocket sampling portion of the project are outlined in Section 2.3.5 and Appendix A.

5 samples were taken from the cloud by B-57D aircraft between 2 and 26 hours post shot time (see Tables B5 & B6). Both the wing tank and coincident samplers were operative on all flights.

A WB-50 aircraft collected samples from the northeastern edge of the fallout pattern at 4, 6, 8, 10 and 11-1/2 hours after the detonation. The fallout was encountered on a bearing of 300-310 degrees at 65, 93, 125, 160 and 187 miles from surface zero. The operation progressed without incident, due mainly to the experience gained by the participating personnel

SAN BUCNO

[REDACTED]

[REDACTED]

on the first two shots.

2.3.5 Rocket Development. The project cloud sampling rocket (see Section 2.2.1) was a new one of complex design. The main motor had been used previously on the ASP (atmospheric sounding projectile) and the sustainer motor on the RTV (reentry test vehicle), but the nose cone and associated equipment had not been used as a component of a rocket before. Development work on a similar sampling device had been done during Operation Plumbbob, and at the end of the operation a satisfactory unit for land recovery had evolved. After Plumbbob, Project 21.3, Task Unit 2, was set up for the purpose of developing a sea recovery version of the rocket for Operation Hardtack. When Project 2.8 was established, the existing rocket contracts were extended to provide additional units for use on this program. Because of the experimental nature of the rocket, the sponsors of this work, UCRL, assessed the probability of obtaining any rocket data as being of the order of 50%.

The development problems were the responsibility of Project 21.3, but a review of their work at the Eniwetok Proving Grounds is of interest since a large portion of Project 2.8 was directly dependent on the availability of a suitable rocket-borne cloud sampler. This review will also serve to provide an explanation of the circumstances which led to the cancellation of the rocket experiment prior to Shot Oak.

SAN BRUNO FRG

[REDACTED]

Notes on the developmental rocket firings and tests are outlined in Appendix A. Details of the firings on Koa and Walnut, which have been given in Sections 2.3.2 and 2.3.3, are not repeated.

2.3.6 Aircraft Samples. The B-57D aircraft used for the cloud sampling work were under the control of a LASL representative. The person responsible for these collections communicated with the aircraft by normal voice radio from the Air Operation Center on Site Fred. The fallout samples were taken by WB-50 aircraft controlled by an NRDL representative. They were directed from the Air Weather Central on Site Elmer using CW radio communication. The transmitters used by the Air Weather Central operated on a long wave length, thereby making it possible to maintain radio contact with the WB-50's at long ranges and low altitudes.

Estimated coordinates for each sampling position on the height line flights were furnished by the Fallout Prediction Unit (FOPU). The initial 4 hour position prediction was based solely on the wind data available at shot time, but contacts made by the sampling aircraft, plus additional wind data, assisted in preparing the later estimates. Interchange of information between FOPU and the Air Weather Central was maintained throughout the sampling flights.

The FOPU predictions were generally quite accurate with respect to

[REDACTED]

radial distance from ground zero, but the wind information was not always adequate to determine the angular position. For example, on Koa the estimated height line bearing was 0 degrees but the sampling aircraft encountered fallout at a polar angle of 50 degrees. For Walnut the 4-hour sampling position given was quite accurate, but the later curving of the height line toward the west could not be predicted. Sampling position estimates were the best of all on Oak and even the most distant points were predicted within 2 degrees in bearing and 3 miles in distance.

Table^s B1-B6 give a summary of all the samples collected by aircraft for the project. It will be noted that in addition to the cloud samples taken from the light and variable layer, there were several samples on each shot from lower altitudes. Analytical data for these samples is included since they give information on the variation of cloud composition with altitude (see Appendix D).

2.4 PARTICLE WORK

Some investigation of particle characteristics was carried out for all the cloud and height line samples from Shot Koa which were large enough to work with. Approximately one quarter of each filter paper from the cloud samples, and one section from the E-1 sampler, were shipped to UCRL by the first flyaway following the shot. On each sample the filter

[REDACTED]

paper was removed by burning off in a stream of atomic oxygen from a gas discharge generator. The maximum temperature reached during burnoff was around 200° C. The weight of material recovered varied from 50 mg. to about 4.5 gm.

At UCRL some of the cloud samples were separated into coarse and fine fractions using a Bahco centrifuge and fall rate distribution curves were determined for the two fractions with the micromerograph. Fall rate data were also obtained for all the height line samples and in several cases the specific activity-fall rate curves were determined for cloud and fallout samples. In operating the micromerograph the weight could either be recorded continuously or in 16 increments by means of individual pans on a rotating turntable.

Two of the height line samples and three cloud samples, separated into coarse and fine fractions with the Bahco, were transmitted from UCRL to NRDL for examination. The chemical substances present in these samples were identified with the polarizing microscope and by X-ray diffraction, and the particle size distributions determined by microscopic observation. A binocular microscope fitted with ocular micrometers containing a linear scale was used for the particle work. Each scale division of the micrometer represented 15 microns for the magnification used (100X). A portion of the sample was placed on a microscope slide and tapped gently

SAN BRUNO TR

~~SECRET~~

to disperse the particles. Traverses were made along the slide from one extreme edge of the dispersion to the other and every particle within the micrometer scale was sized and typed. Generally, several appropriately spaced traverses were taken. The particles were sized in terms of maximum diameter and typed by the conventional classification of irregular, spherical and agglomerated. Diameters were measured to the nearest one-half scale division and particles less than a half unit were ignored. Particles adhering to each other were sized individually, if possible, or otherwise not taken into account.

Particle characteristics, fall-rate and size distribution curves are given in Appendix C. No particle work was done on the samples from Oak and Walnut.

2.5 SAMPLE ANALYSIS AND RADIOCHEMICAL PROCEDURES

Radiochemical analyses were carried out on the gross particulate cloud samples from the wing tank collectors, on size-separated cloud samples, on the gas-particulate samples from the coincident units and on the fallout samples. The major part of the analytical work on the cloud and fallout particle samples was done by NRDL (some by LASL), while the gas-particle samples for the determination of fission ratios (Section 1.2.4) were analyzed at UCRL.

SAN BRUNO IRE

The gross particulate and fallout samples were shipped to NRDL on filter papers as collected in the field. The size-separated samples were prepared at UCRL by the oxygen burnoff and centrifuge technique described in Section 2.4, and then transmitted to NRDL. 2 particle groups were separated for the Koa and Oak samples and 3 for Walnut (see Appendix B).

At NRDL the samples were prepared for analysis by wet ashing with fuming HNO_3 and HClO_4 to destroy organic material, then fuming with HF to remove silica. The HF was expelled by again fuming with HClO_4 and the resulting solution was transferred to a volumetric flask and diluted to volume with 4N HCl. Aliquots of the HCl solutions were taken for the analyses. A total of 1040 radionuclide determinations and 41 elemental analyses (see Section 1.3.5) were performed at NRDL using the following procedures:

1. Elemental Na and Ca were determined with the flame photometer using a matrix very similar to the constituents of coral.

2. Mo^{99} was determined by either of two methods, depending on the age of the sample. A carrier-free anion exchange method (Reference 67) was used for fresh samples, while a modified precipitation method (Reference 68) was used for older samples.

3. Eu^{156} , Y^{91} , and Ce^{144} were measured by a cation exchange pro-

cedure after preliminary separation of the rare earth group by precipitation reactions and anion exchange (Reference 62).

4. Ca^{45} was separated by a procedure using precipitation reactions. Ba and Sr were removed by precipitation as the nitrates using fuming HNO_3 under controlled conditions. The Ca was recovered from the nitric acid solution by precipitation as the sulfate. The sulfate was then dissolved, scavenged twice with Zr, Te, Fe and La hydroxides, once with basic Mo and Cd sulfides and once with acidic Mo and Cd sulfides. Ca was precipitated as the oxalate for mounting and counting.

5. Sr^{89} and Sr^{90} were originally separated by precipitation procedures (References 63 and 64). For the determination of Sr^{90} , the Y^{90} was allowed to grow into equilibrium, the SrCO_3 precipitate dissolved in HNO_3 containing Y carrier, Y $(\text{OH})_3$ precipitated with ammonia gas and the Sr removed as the nitrate in fuming nitric acid. The Y was precipitated as the oxalate from an acetic acid solution in the pH range 3-5 and ignited to the oxide for mounting and counting.

6. The Cs procedure used for the determination of Cs^{136} and Cs^{137} was a modification by the original author of a precipitation and ion exchange procedure (Reference 65). The modification consisted mainly of a Cs tetraphenyl boron precipitation in the presence of EDTA, the use of Dowex-50 in place of Duelite C-3 in the cation exchange step and the addition of an anion exchange step.

SAN BRUNO ITC

[REDACTED]

The radiochemical work reported as being done at LASL was performed in conjunction with diagnostic measurements on the events. The methods used were those reported in the Los Alamos compilation of radiochemical procedures (Reference 66).

The gas samples were analyzed for Kr^{88} , Kr^{85} , Kr^{85m} and in some cases for Xe^{133} . The rare gas radionuclides were separated from the constituents of the atmosphere and then counted in a gas counter. The separation procedure used was developed at UCRL, Livermore, under the direction of Dr. Floyd Momyer. Carrier amounts of inactive Kr and Xe were added to the air sample and the mixture circulated through a series of traps for purification purposes. Water and carbon dioxide were condensed out in the first trap, which was filled with inert packing and held at liquid nitrogen temperature. The Kr and Xe were absorbed on activated charcoal in a second trap, also immersed in liquid nitrogen, but the major part of the N_2 , O_2 and A passed through the trap and were removed. The Kr was desorbed by raising the trap temperature to that of a dry ice-acetone mixture. Further purification was effected by two more absorption-desorption cycles on charcoal at liquid nitrogen and dry ice-acetone temperatures. After determination of the pure Kr yield, it was transferred to the gas counter.

This was the procedure used when Kr alone was the desired product; additional purification steps were necessary when Xe was also determined.

SAN BRUNO FRC

2.6 DATA REDUCTION

The analytical results were computed in the normal manner for the elemental analyses done for the project. However, the first, and more time-consuming phases of the data reduction were carried out on the IBM 650 computer at UCRL, Livermore. The radiochemical data were manually transcribed to IBM cards in the proper form for use by the computer, which was coded to apply a least-squares fit to the decay data and to make corrections for chemical yield, radioactive decay and the aliquot of the sample used. The output of the computer gave the counting rates for the individual radionuclides at zero time of the shots.

Further computation was performed by hand to obtain the number of fissions, product-to-fission ratios or R-values. Determination of the R-values, defined in Section 1.2.1, required calibration values on fission products from the thermal neutron fission of U^{235} . When these were not available, or only recently obtained, comparison analyses between LASL and NRDL provided the necessary factors.

CHAPTER III
RESULTS AND DISCUSSION

3.1 DISCUSSION AND INTERPRETATION OF THE DATA

It is noted that the achievement of project objectives 1, 2 and 3 depended wholly or in part on the proper functioning of the rocket samplers. Due to their failure, there are no results to be reported on the vertical and radial distribution of particles in the clouds, which was objective 3. However, objectives 1 and 2 were partially met and 4 was fully met by the aircraft samples.

Referring to the nuclides listed in Section 1.3.5, it is to be observed that those in group 2, namely Sr^{89} , Y^{91} , Cs^{136} , Ce^{144} , Eu^{156} and U^{237} , were included for the purpose of developing a general background of information on nuclide fractionation. This material may serve as the basis for a separate report, but it is not being considered here since it was not a primary concern of Project 2.8. Only the data which has a bearing on the distribution of the nuclides Sr^{90} and Cs^{137} in the fallout will be covered in this chapter. The radiochemical results for each of the four different types of samples collected each contribute something to the overall evaluation.

3.1.1 Cloud Data. For the coincident samples from the light and variable wind layer there are two sets available for Koa, five for Walnut and

six for Oak. The fission product ratios Mo^{99} -to- Kr^{85} and Mo^{99} -to- Kr^{88} calculated for each shot from the sample analytical data are given in Table 3.1. Also listed are the R-values for Sr^{90} and Cs^{137} from the gross particulate samples collected from the cloud at the same time. R-values characteristic of megaton range detonations are 0.77 for Sr^{90} and 0.90 for Cs^{137} . Subject to the assumptions inherent in the method, the fission product ratios give directly that fraction of the total Mo^{99} formed in the explosion which was left in the cloud at the time of sampling. Multiplication of these numbers by the cloud R-values and division by the device R-values convert them to the fractions of the nuclides remaining in the clouds. The last step is necessary to correct for the difference in fission yields between device neutrons and thermal neutrons (see Section 1.2.1). The samples in the table are identified by aircraft numbers as in Appendix B, to which reference should be made for further details.

The calculated fractions of Mo^{99} , Sr^{90} and Cs^{137} in the cloud, based on the Kr^{88} fission product ratios, are plotted as a function of time in Figures 3.1, 3.2 and 3.3. Kr^{88} was not determined on the 27-hour samples from Walnut and Oak due to its low counting rate at that time. The points on the curves for these shots at 27 hours are based on the Mo^{99} -to- Kr^{88} fission product ratios corrected by the Kr^{88} -to- Kr^{85} ratio at 12 hours. On Koa the late-time fission ratio is extrapolated and the Sr^{90} and Cs^{137} fractions

SAN BRUNO ERG

DELETED

SAN BRUNO FRC

3.1

-71-

71

DELETED

FIG. 3.2

SAN BRUNO FRU

DELETED

SAN BRUNO FR

FIG 3.3

-73-

7

73

TABLE 3.1

PARTICLE-GAS FISSION RATIOS AND R-VALUES FOR SAMPLES FROM LIGHT AND VARIABLE WIND LAYER

Sample	<u>KOA</u>			<u>WALNUT</u>			<u>OAK</u>		
	<u>Fission Product Ratios</u>	<u>R-Values</u>	<u>Fission Product Ratios</u>	<u>R-Values</u>	<u>Fission Product Ratios</u>	<u>R-Values</u>			
	Mo^{99}/Kr^{85}	Mo^{99}/Kr^{85}	Mo^{99}/Kr^{85}	Mo^{99}/Kr^{85}	Mo^{99}/Kr^{85}	Mo^{99}/Kr^{85}	Mo^{99}/Kr^{85}	Mo^{99}/Kr^{85}	Mo^{99}/Kr^{85}
		0.8^{137}	0.8^{137}	0.8^{137}	0.8^{137}	0.8^{137}	0.8^{137}	0.8^{137}	0.8^{137}
		Sr^{90}	Sr^{90}	Sr^{90}	Sr^{90}	Sr^{90}	Sr^{90}	Sr^{90}	Sr^{90}

DELETED

AN BRUNO FR

are calculated from R-values averaged throughout the cloud for the first four hours. The fractions for Oak are also from averages, here in the light and variable stratum, while for Walnut the stabilized condition shown in Figure 3.1 is used. Sample 980 L for Oak is not included due to the poor sampling conditions.

The fractions of these nuclides remaining in the cloud after one day are given in Table 3.2. These numbers are to be interpreted as the quantity of material which does not come down in the local area. The limits assigned are derived from the variability in the data.

PERCENT TABLE 3.2
FRACTIONS OF NUCLIDES LEFT IN CLOUD AFTER ONE DAY

	<u>Mo⁹⁹</u>	<u>Sr⁹⁰</u>	<u>Cs¹³⁷</u>
Koa	4 \pm 4 -0	20	64
Walnut	30 \pm 5	41	78
Oak	15 \pm 10	45	61

Of the curves for the fraction of Mo⁹⁹ left in the clouds, the one for the water surface burst shows to a considerable degree the behaviour anticipated when the project was planned. On the reef shot, the points appear to be fluctuating around a fraction of 0.15, whereas for the land surface detonation there is insufficient data to do anything but extrapolate beyond 6.5 hours. Since it is likely that the fission ratios would be around one

SAN BRUNO FIG

initially, the curves shown for Oak and Koa may be only the relatively flat part which appears for Walnut at a later time. This seems to be consistent with what is surmised about the cloud particle size distribution for land and water shots.

In addition to the samples from the light and variable wind layer, there were also a number of collections made on each shot at lower altitudes. Although not of direct application to the project objectives, the radiochemical data for these samples is instructive since it shows how the nuclide composition of the particulate matter varied with altitude. Some of the samples came from the bottom portions of the clouds, but those collected at the lowest altitudes may have been below the base of the mushroom and would perhaps be considered as fallout. Table 3.3 gives a summary of the Sr^{90} and Cs^{137} R-values for the three shots as related to altitude and time of collection. The R-values for the samples marked with an asterisk were calculated as gross figures from the R-values for the size-separated fractions. For the land surface shot the R-values show a general increase with altitude, attaining values at 60,000 feet which are 10 (Sr^{90}) to 40 (Cs^{137}) times those expected for the detonation. The water shot R-values are relatively insensitive to altitude, and the enrichment factor is not more than 2 for either nuclide. Samples collected below 45,000 feet may be from the

SAN BRUNO FRC

TABLE 3.3
Sr90 AND Cs137 R-VALUES VS ALTITUDE

		<u>KOA</u>				<u>WALNUT</u>				<u>OAK</u>			
Sampling Altitude, Feet	Sampling Time Hrs.	R ⁹⁹ (90)	R ⁹⁹ (137)	Sampling Altitude, Feet	Sampling Time, Hrs.	R ⁹⁹ (90)	R ⁹⁹ (137)	Sampling Altitude, Feet	Sampling Time Hrs.	R ⁹⁹ (90)	R ⁹⁹ (137)		
39,000*	3	0.47	1.37	42,000	2.5	0.75	1.00	45,500	3.9	0.29	0.46		
40,000	2.3	0.72	0.59	44,000	3.1	1.27	1.94	47,000	2.8	0.30	0.42		
45,000	2.75	1.32	3.05	48,000	3.15	1.39	2.02	49,000	3.25	0.41	0.42		
45,000*	3.5	0.69	3.20	50,000	3.7	1.49	2.17	54,000	3.75	0.52	0.63		
49,000	3.0	0.77	0.71	57,500	1.6	1.07	1.77	56,400	2.1	1.72	3.67		
56,000	6.5	1.37	3.85	58,000	3.4	0.94	1.33	55,000*	2.1	1.23	4.82		
56,000*	6.5	1.40	4.44	64,000(?)	6.8	1.08	1.69	64,000(?)	3.2	2.32	5.48		
60,000	7.3	7.76	39.0	57,800	12.3	1.18	1.81	56,300	6.0	3.15	7.50		
60,000*	8	7.06	33.8	58,500	27.5	1.16	1.84	56,300	12.3	3.24	7.21		
60,000*	11	8.30	46.2					55,000	26.8	1.32	2.04		
60,600	4.5	5.62	27.8					55,000*	26.8	1.56	2.02		
60,600*	4.5	10.50	38.08										
Device		0.77	0.90			0.77	0.90			0.77	0.90		

*Calculated as gross figures from the R-values for the size-separated fractions.



fallout.

On the reef shot it appears that the sampling planes were just entering the base of the cloud at the 55,000 foot level since there is a sudden jump in the R-values at this point. The material collected at lower altitudes is depleted in both Sr^{90} and Cs^{137} and is not greatly different in composition from the fallout at 1000 feet. It is also noted that the enrichment factors for both nuclides go through a maximum with time for the samples from the light and variable stratum. This might be interpreted as indicating a concentration on particles of some size intermediate between the early and late fallout from this region.

Somewhat similar data for the Mo^{99} -to- Kr^{88} and Kr^{88} -to- Kr^{85} ratios for the first four hours following detonation are given in Table 3.4. The Mo^{99} to Kr^{88} ratios are also shown graphically in Figure 3.4. At the lower altitudes the Mo^{99} is enriched and the Kr^{88} depleted with respect to Kr^{85} .

3.1.2 Fallout Data. The radiochemical data on the fallout samples may be used to obtain results for the distribution of Sr^{90} and Cs^{137} which are complementary to those found from the cloud analyses. The fraction of the total Mo^{99} formed in the explosion which has left the cloud is found by difference from the numbers given in Table 3.2. Multiplication of these figures by the Sr^{90} and Cs^{137} R-values for the fallout and division

SAN BRUNO ERC

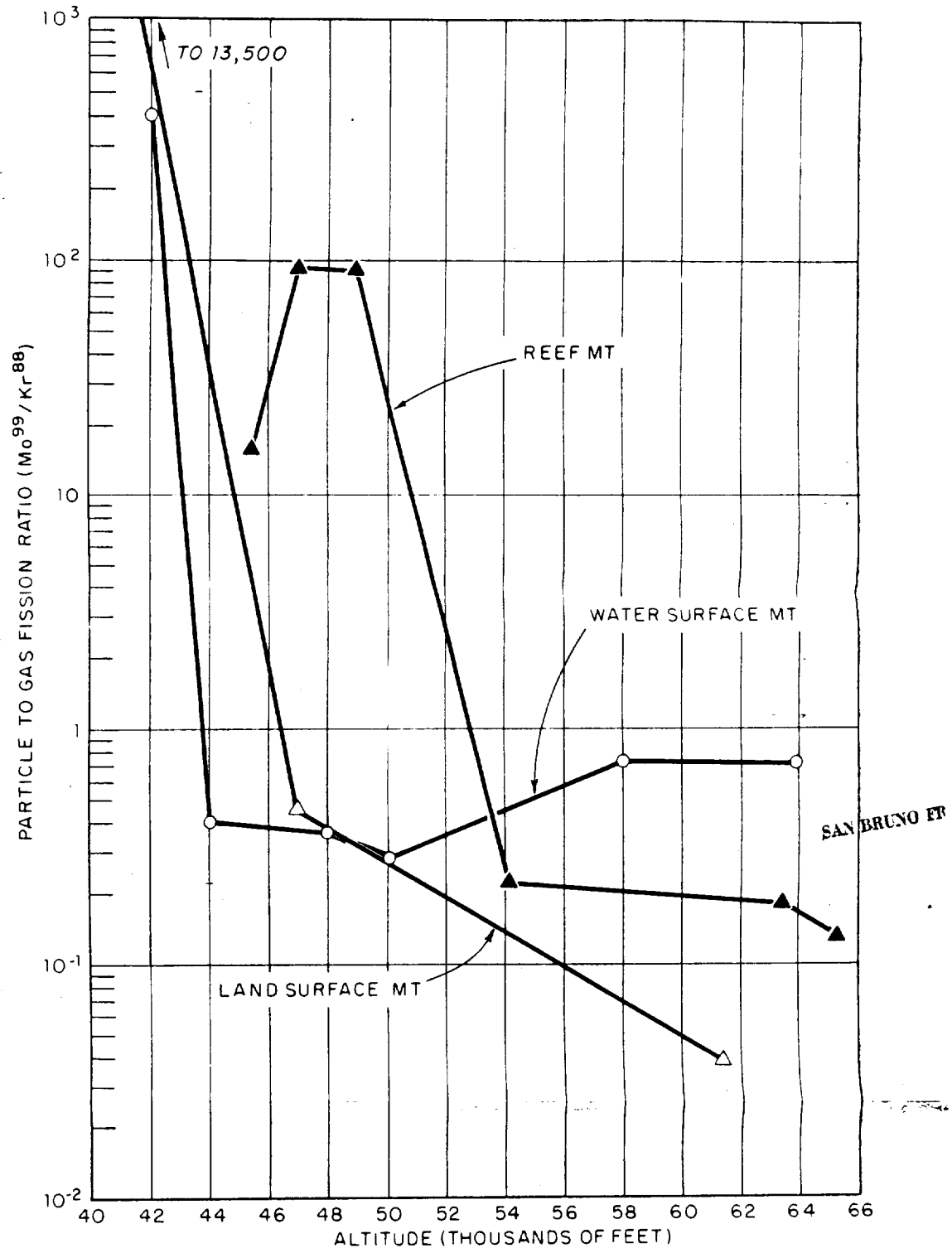

UNCLASSIFIED

FIG. 3.4

2979

TABLE 3.4

Mo-TO-Kr AND Kr-88 TO Kr-85 RATIOS FOR FIRST FOUR HOURS,
SHOT KDA

<u>Sample No.</u>	<u>Sampling Time, hrs</u>	<u>Sampling Altitude, Feet</u>	<u>Mo⁹⁹/Kr⁸⁵</u>	<u>Mo⁹⁹/Kr^{85m}</u>	<u>Mo⁹⁹/Kr⁸⁸</u>	<u>Kr⁸⁸/Kr^{85m}</u>	<u>Kr⁸⁸/Kr⁸⁵</u>
502 R	2.5	41,000	192.9	270.0	13,500	0.02	0.014
500 L	3.5	47,000	0.32	0.49	0.44	1.11	0.73
500 R	3.5	47,000	----	----	0.98	----	----
977 R	3.75	61,500	----	0.052	0.038	1.38	----

continued

SAN BRUNO TRC

TABLE 3.4, CONT'D
Mo-TO-Kr AND Kr-88 TO Kr-85 RATIOS FOR FIRST FOUR HOURS,
SHOT WALNUT

Sample No.	Sampling Time, hrs	Sampling Altitude, Feet	Mo ⁹⁹ /Kr ⁸⁵	Mo ⁹⁹ /Kr ^{85m}	Mo ⁹⁹ /Kr ⁸⁸	Kr ⁸⁸ /Kr ^{85m}	Kr ⁸⁸ /Kr ⁸⁵
501 L	2.5	42,000	2.14	3.44	420.8	0.0082	0.00508
504 L	3.1	44,000	0.66	0.60	0.41	1.47	1.63
504 R	3.1	44,000	0.59	---	---	---	---
496 L	3.15	48,000	0.61	0.53	0.36	1.47	1.69
496 R	3.15	48,000	0.46	0.54	0.38	1.43	1.21
500 R	3.7	50,000	0.47	0.43	0.28	1.52	1.66
982 L	1.6	58,000	0.72	0.67	0.73	0.92	0.98
982 R	1.6	58,000	0.73	0.59	0.70	0.84	1.04
980 L	3.4	58,000	0.60	0.50	0.71	0.71	0.84
980 R	3.4	58,000	0.65	0.54	0.73	0.73	0.88

continued

SAN BRUNO INC

TABLE 3.4, CONT'D
Mo-TO-Kr AND Kr⁸⁸ TO-Kr⁸⁵ RATIOS FOR FIRST FOUR HOURS,
SHOT OAK

Sample No.	Sampling Time, hrs	Sampling Altitude, Feet	Mo ⁹⁹ /Kr ⁸⁵	Mo ⁹⁹ /Kr ^{85m}	Mo ⁹⁹ /Kr ⁸⁸	Kr ⁸⁸ /Kr ^{85m}	Kr ⁸⁸ /Kr ⁸⁵
501 L	3.9	45,500	1.67	--	--	--	--
501 R	3.9	45,500	1.45	1.21	15.3	0.079	0.095
504 L	2.8	47,000	4.48	4.63	95.0	0.049	0.047
504 R	2.8	47,000	3.08	--	--	--	--
496 L	3.25	49,000	5.29	5.00	92.5	0.054	0.057
496 R	3.25	49,000	4.52	--	--	--	--
495 L	3.75	54,000	1.85	1.51	2.19	0.69	0.84
978 L	2.1	56,400	0.15	0.15	0.11	1.36	1.40
978 R	2.1	56,400	0.19	0.18	0.14	1.25	1.31
981 R	3.2	?	0.25	0.21	0.18	1.18	1.39

SAN BRUNO TRC

by the device R-values convert them to fractions of the two nuclides in the fallout. Table 3.5 lists results obtained in this way based on the averaged composition for the fallout.

TABLE 3.5

DATA ON NUCLIDES IN FALLOUT

	<u>R-Value(Average)</u>		<u>Fraction Deposited</u>		
	<u>Sr⁹⁰</u>	<u>Cs¹³⁷</u>	<u>Mo⁹⁹</u>	<u>Sr⁹⁰</u>	<u>Cs¹³⁷</u>
Koa	0.52	0.44	0.96	0.65	0.47
Walnut	0.78	1.13	0.70	0.71	0.88
Oak	0.45	0.40	0.85	0.49	0.37

The sum of the nuclide fractions from the cloud and fallout should be one in each case provided that the R-values used are representative of the cloud and fallout as a whole. This seems to be likely for the fallout where the R-values change only relatively slightly with time but more doubtful in the cloud due to the scatter of the analytical results. Table 3.6 gives a comparison between the deposited and airborne fractions. The agreement is perhaps generally as good as could be expected considering the nature of the data.

SAN BRUNO ITC

All the samples from the land and reef shots show depletion of both Sr⁹⁰ and Cs¹³⁷ as compared to the detonation yields. This is most pronounced in the earliest samples. Material coming down at times later than

TABLE 3.6

COMPARISON OF AIRBORNE AND DEPOSITED FRACTIONS

	<u>Sr⁹⁰</u>			<u>Cs¹³⁷</u>		
	<u>Fraction Deposited</u>	<u>Fraction Airborne</u>	<u>Total</u>	<u>Fraction Deposited</u>	<u>Fraction Airborne</u>	<u>Total</u>
Koa	0.65	0.20	0.85	0.47	0.64	1.11
Walnut	0.71	0.41	1.11	0.88	0.78	1.66
Oak	0.49	0.45	0.94	0.37	0.61	0.98

4 hours for the land shot, and 6 hours for the reef shot, is quite uniform in composition and exhibits little evidence of fall rate-dependent fractionation. Sr⁹⁰ is generally more depleted in the reef shot than the land shot, while the reverse is true for Cs¹³⁷.

The 4-hour fallout from the water surface shot is depleted in both nuclides, but the 10- and 13-hour samples show an enrichment. The two latter samples have nearly the same composition. The failure of the 6- and 8-hour flight missions makes the data rather scanty in this case.

These effects are brought out clearly by the numbers listed in Table 3.7.

3.1.3 Combined Cloud and Fallout Data. Another way of estimating the fraction of Mo⁹⁹ left in the cloud, independent of the fission ratios, is based on a material balance for some nuclide, Y. R-values for nuclide Y

TABLE 3.7
ENRICHMENT FACTORS IN FALLOUT

Sample No.	Sampling Time, hrs	KOA			WALNUT			OAK			
		R ₁	R ₂	Sample No.	Sampling Time, hrs	R ₁	R ₂	Sample No.	Sampling Time, hrs	R ₁	R ₂
Massive L1	4	0.62	0.37	Massive 1 R1	4	0.68	0.63	Massive R1	4	0.58	0.20
Massive R2	6	0.68	0.54	Massive 2 R1	10	1.25	1.57	Massive R2	6	0.49	0.24
Massive R3	8	0.68	0.54	Massive 2 R2	13	1.13	1.57	Massive R3	8	0.63	0.59
Massive R4	10	0.68	0.52					Massive R4	10	0.63	0.61
Massive R5	12	0.70	0.50					Massive R5	12	0.60	0.58
Wilson Sp. R	6	0.69	0.48								

$$R_1 = [R^{99}(90)]_{F0} : [R^{99}(90)]_E = \frac{\text{Ratio of Sr}^{90} \text{ to Mo}^{99} \text{ observed in fallout}}{\text{Ratio of Sr}^{90} \text{ to Mo}^{99} \text{ expected from the device}}$$

$$R_2 = [R^{99}(137)]_{F0} : [R^{99}(137)]_E = \frac{\text{Ratio of Cs}^{137} \text{ to Mo}^{99} \text{ observed in fallout}}{\text{Ratio of Cs}^{137} \text{ to Mo}^{99} \text{ expected from the device}}$$

SAN BRUNO ERG

in the explosion (E), cloud (C) and fallout (FO) are used in the formula:

$$y = \frac{[R^{99}(Y)]_E - [R^{99}(Y)]_{FO}}{[R^{99}(Y)]_C - [R^{99}(Y)]_{FO}}$$

y is the fraction of Mo⁹⁹ left in the cloud and the other quantities are the designated R-values. This formula can be derived by algebraic operations from the definitions of the R-values (see Appendix E). The method seems to be basically valid, but in practice it gives discordant values for y when different nuclides are used in the material balance. Hence it has not been possible to use it as an auxiliary method for calculating the fallout distribution.

3.2 DATA RELIABILITY

3.2.1 Cross-Contamination Of Koa Samples. As discussed in Section 2.3.2, a preliminary examination of the samples from Shot Koa, shortly after their receipt at LASL, indicated that they might be badly contaminated with debris from Fir. If this were the case, the fission ratios from the Koa cloud data could not be used for the determination of fallout partition since they would not be representative of the detonation. To investigate the extent of cross-contamination, the Koa samples were analyzed for a nuclide formed with a high yield in Fir but not in Koa. Table 3.8 gives a summary of the results of this work.

DELETED

TABLE 3.8

DELETEDANALYSES ON KOA CLOUD SAMPLES

<u>Sample Number</u>	<u>Product:Fission Ratio</u> <u>DELETED (x 10⁴)</u>
977	
569	
500	
502	
981 L	
981 R	
980 L	
Massive R4	
Massive R5	
Wilson Special R6	

DELETED**DELETED**

It is evident

that the Koa samples contain at most a little over 1% of material from the Fir cloud, and generally much less. Hence the quantities of Mo and Kr introduced into the Koa cloud from Fir were small enough so that they would have a negligible effect on the fission ratios.

3.2.2 Accuracy of Radiochemistry. Radionuclide analyses on the particle samples were accurate to 5 percent on a relative basis and the gas counting had an accuracy better than 10 percent.

3.2.3 Reliability of Sampling. Certain points on the curves of Figure 3.1 are to be attributed somewhat less significance than the others due to uncertainties regarding the samples. On Koa the fission ratio for sample

SAN BRUNO FRG

981 R may be off by a factor of 2 due to the small sample size which would decrease the counting accuracy. On Walnut sample 978 L (27.5 hr.) the probe velocity was low and Kr⁸⁵ only was determined. Sample 980 L for Oak has been disregarded due to the very low probe velocity which would tend to make the Mo⁹⁹ to Kr⁸⁸ ratio too high.

3.3 COMPARISON WITH THE RESULTS OF PREVIOUS TESTS

Shots were fired during Operation Redwing under conditions similar to those of the present series and some data are available from published reports which may be used for comparison purposes. Results on the Mo⁹⁹ to Kr⁸⁸ ratios and Sr⁹⁰ R-values as a function of altitude in the cloud for the first four hours are reproduced in Table 3.9 from Reference 26. It is noted that for the land and reef shots the Sr⁹⁰ R-values increase and the Mo⁹⁹ to Kr⁸⁸ ratios decrease in a way generally comparable to the similar Hardtack events. On the water shot the Sr⁹⁰ R-values are nearly constant with altitude, as with Walnut, but the Mo⁹⁹ to Kr⁸⁸ ratios are not comparable.

The fallout R-values are generally not inconsistent with those arrived at for the Redwing shots by Project 2.63. In view of the fact that the latter lead to radionuclide compositions which generate computed decay curves in good agreement with those actually measured on several different kinds of instruments, this agreement is impressive. The fractionation-

TABLE 3.9

CLOUD DATA, OPERATION REDWING

Altitude, feet	Land Shot (Zuni)		Reef Shot (Tewa)		Water Shot (Navajo)			
	R99(90)	Mo88:Kr88	Altitude, feet	R99(90)	Mo99:Kr88	Altitude, R99(90) feet	Mo99:Kr88	
41,000	0.51	50.0	32,000	0.44	16.6	39,000	0.75	14.3
51,000	0.64	2.5	48,000	0.47	14.3	43,000	0.64	100.0
55,000	2.0	0.11	51,000	0.86	0.77	46,000	0.68	100.0
			53,000	1.5	0.59	50,000	---	0.54

a. Reference 26.

SAN BRUNO TRC

corrected R-values from Redwing are listed in Table 3.10; for the land surface and reef shots, cloud and close-in fallout values are given to show the range.

TABLE 3.10

FRACTIONATION-CORRECTED R-VALUES FOR REDWING

<u>Shot</u>	<u>R⁹⁹(90)</u>			<u>R⁹⁹(137)</u>		
	<u>Cloud</u>	<u>Close-in</u>	<u>Average</u>	<u>Cloud</u>	<u>Close-in</u>	<u>Average</u>
Water Surface, KT --	--	--	0.34	---	---	0.32
Water Surface, MT --	--	--	1.0	---	---	1.0
Reef, MT	1.0	0.078	--	1.0	0.03	--
Land Surface MT 2.3		0.078	--	1.8	0.03	--

3.4 EFFECTIVENESS OF INSTRUMENTATION

The aircraft-borne sampling equipment performed in a generally satisfactory manner throughout the entire operation with the exception of some malfunctioning of the gas compressor pumps on the first shot. This was due primarily to the shortage of time for checkout prior to actual operational use. As the participating personnel gained experience, communications improved and the sampling flights progressed more smoothly. Each of the three types of aircraft sampling equipment is considered to be well suited for its intended use.

SAN BRUNO

[REDACTED]

Difficulties experienced with the rocket samplers are fully described in Chapter II and Appendix A.

SAN BRUNO IRE

[REDACTED]

CHAPTER IV

CONCLUSIONS AND RECOMMENDATIONS

4.1 CONCLUSIONS

1. The results suggest that for megaton range weapons detonated at or near the ocean surface, around one-half of the Sr^{90} and two-thirds of the Cs^{137} formed will be dispersed over distances greater than 4,000 miles.
2. Corresponding figures for a calcareous land surface are around one-fifth for Sr^{90} and one-half for Cs^{137} . More uncertainty is associated with these values due to the poorer quality of the data.
3. Radionuclide fractionation is pronounced in shots over a calcareous land surface. The local fallout is depleted in both Sr^{90} and Cs^{137} , while the upper portions of the clouds are enriched. Fractionation is much less for water surface shots.
4. Nuclear clouds are non-uniform in composition and certain nuclide ratios vary by rather large amounts from top to bottom. Again, this is much larger for land than water surface detonations.
5. Sr^{90} and Cs^{137} distributions computed from cloud and fallout data are roughly complementary to one another.

SAN BRUNO ITC

4.2 RECOMMENDATIONS

It is recommended that similar sampling operations, both of the clouds and the fallout, be carried out if the opportunity is presented by future weapons tests. Attention might be directed principally toward land surface detonations, where the Hardtack data are relatively poor. Since the sampling techniques are well developed, the operational costs for such a project would be small with the main expense in the chemical analyses. This could be reduced, if necessary, by restricting the radiochemistry to the long-lived nuclides.

SAN BRUNO LEG

APPENDIX A

ROCKET DEVELOPMENT

A.1 HARDTACK PERFORMANCE

6 May Test

Four rockets were set up on Site Yvonne for testing during Shot Cactus, a 14-kt. detonation; two were located at 3200 feet from ground zero, while the others were placed at a position some 5000 feet further down-island. It was planned to fire both of the down-island rockets and one of those situated at 3200 feet to check out the performance of the array prior to operational use on Shot Koa. The remaining rocket was to be left unfired on its launcher so that the results of exposure to the detonation could be observed. The launching equipment for this rocket was rendered inoperative by the blast, but neither of the rockets at the close-in site were damaged. Both of the down-island rockets fired, and one penetrated the cloud and was recovered from the lagoon. However, it collected no activity since the cloud height was less than predicted and the sampler head was programmed to open at an altitude higher than the resultant cloud top. The second rocket flew in an erratic manner, missed the cloud and sank. Its nose cone was recovered from the bottom of the lagoon and a post-mortem examination indicated that the rocket had probably been damaged by a flying object prior to launching.

SAN BRENO ERG

9 May Test

Two rockets were fired from Site Wilma for system check and nose cone recovery practice, but both cones were leaky and sank soon after striking the water. The cause of the leakage was not known, but it was thought that a contributing factor might have been the existence of a partial vacuum inside the sampling heads, since they were sealed at an altitude of about 80,000 feet where the ambient pressure is much below that at sea level. To correct this situation, small holes of about 0.040 inch diameter were drilled in the nose cones and coated with a hydrophobic grease, thereby allowing air pressure equalization without permitting the entry of water. Static tests showed that no water entered the sampler heads by this route.

13 May Test

Eighteen rockets were set up for firing at the Koa cloud, but, as described previously, none were launched (see Section 2.3.2).

26 May Test

After modification and testing of the launching equipment subsequent to Shot Koa, it was believed that the system was fully operational. It was desired at this time to test the complete array with a full complement of rockets. Four rockets were set up on Site Mary, eight on Site Sally and 6 on Site Wilma for firing at the Yellowwood cloud. The cloud

[REDACTED]

from Shot Yellowwood did not develop to the extent predicted, and launching signals were sent only to the launchers on Mary and Sally at H / 13-1/2 minutes. All rockets launched successfully. The rockets on Wilma were intentionally not launched, because it was apparent that their trajectories would not intersect the cloud. Even of those fired, four were seen to have missed the cloud. Three nose cones were recovered. The cap on the first nose cone was still intact, probably due to a short in the circuit that fired the nose cap removal squib; therefore, no sample was collected. The second nose cone was from a rocket programmed to open at 30,000 feet. When recovered, the nose cone contained about 60 ml. of water. At H / 9 hours the filter of this nose cone read about 1 mr. /hr. at the surface. The third nose cone was from a rocket programmed to open at 55,000 feet. About 100 ml. of water had leaked into it, and the surface reading of its filter was 25 mr. /hr at H / 9-1/2 hours. After this shot, an intensive effort was made to determine the cause of leakage of water into the nose cones. It was found that the ball joint sealing the forward end of the nose cone after sampling could bounce back a small amount after closure, thereby permitting water to enter. A latching mechanism was designed to lock the ball joint in its totally closed position. This modification was then applied to all nose cones.

SAN BRUNO ERG

1 June Test

Three rockets were fired from Site Wilma to test the modified ball joint closure mechanism. The sustainer motor on the first rocket did not ignite, causing the nose cone to remain attached to this unit which fell into the lagoon and sank. The second rocket was damaged by impact with a coral head. The third nose cone was recovered intact and was dry inside. This represented a completely successful performance of the system. It appeared that the problem of water leakage into the nose cone had been solved.

19 June Test

Ten rockets were set up for firing at the Walnut cloud. Of these, six were successfully launched (see Section 2.3.3).

20 June Test

Because of the presence of water in the Walnut nose cones, two rockets were fired from Wilma to further investigate the cause of leakage. The nose cone of the first rocket failed to separate from the sustainer motor and was destroyed when it hit the reef. The second nose cone was recovered in the lagoon, and 50 ml. of water was found to have leaked into it. It was conjectured at this time that the low ambient temperature (-100 F°) encountered by the rocket at altitude might be freezing and causing distortion of the O-ring seals.

SAN BRUNO ERC

[REDACTED]

23 June Test

A nose cone with parachute was dropped from a helicopter at an altitude of about 1,500 feet. It was recovered within two and a half minutes after striking the lagoon, and again, 50 ml. of water was found inside. The possibility of impact with the water causing the large rear conical seal to open momentarily now became suspect. This was suggested by the rather large volume of water that had entered in a relatively short time.

24 June Test

Two nose cones with parachutes were dropped from an altitude of 1,500 feet in an effort to determine the exact point of water leakage. In the first nose cone, the filter was replaced by a rubber membrane; and both the fore and aft spaces of the nose cone were stuffed with absorbent paper tissue, so any water leaking in would be retained near the point of entry. After recovery, it was found that no water had leaked into this unit. The second nose cone, which was the same one used in the 23 June test, was also stuffed with tissue. However, a normal filter unit was used to separate the sections rather than a rubber membrane. When recovered, this nose cone was found to be dry inside. There was no difference between recovery conditions on the 23 and 24 June tests, except that the lagoon surface was rough on 23 June and calm on 24 June.

SAN BRUNO ERC

[REDACTED]

LATER RESEARCH

It is seen in Figures A-1 and A-2, illustrating the programming of the rocket and the nose section of the nose section of the rocket, that the system is a complex one.

In the early stages of work on the rocket, prior to the field operation, it had been recognized that the chance of having a completely operational system ready for sampling the HARDTACK clouds was small, due to the short length of time available for development and test firing. Nevertheless, it seemed possible that defects of a minor nature which remained could be rectified in the field. The operational flights and tests already described show that significant progress was made toward this objective.

However, after the tests of 24 June, it became apparent that the cause of nose cone leakage and other malfunctions could not be determined and corrected with facilities available at the Pacific site. Further work, utilizing range and test installations in the United States, was essential to the attainment of a completely successful sampling system. Accordingly, the rocket portion of Project 2.8 was terminated on 27 June with the concurrence of the Chief, AFSWP, and the Division of Military Applications, AEC.; all unfired rounds were shipped to California.

From July to December 1958, the Cooper Development Corp. tested the rockets from the EPG to investigate possible modes of entry of water into the sampling heads (Reference 57).

Three nose cones identical to those flown in the last Pacific rounds

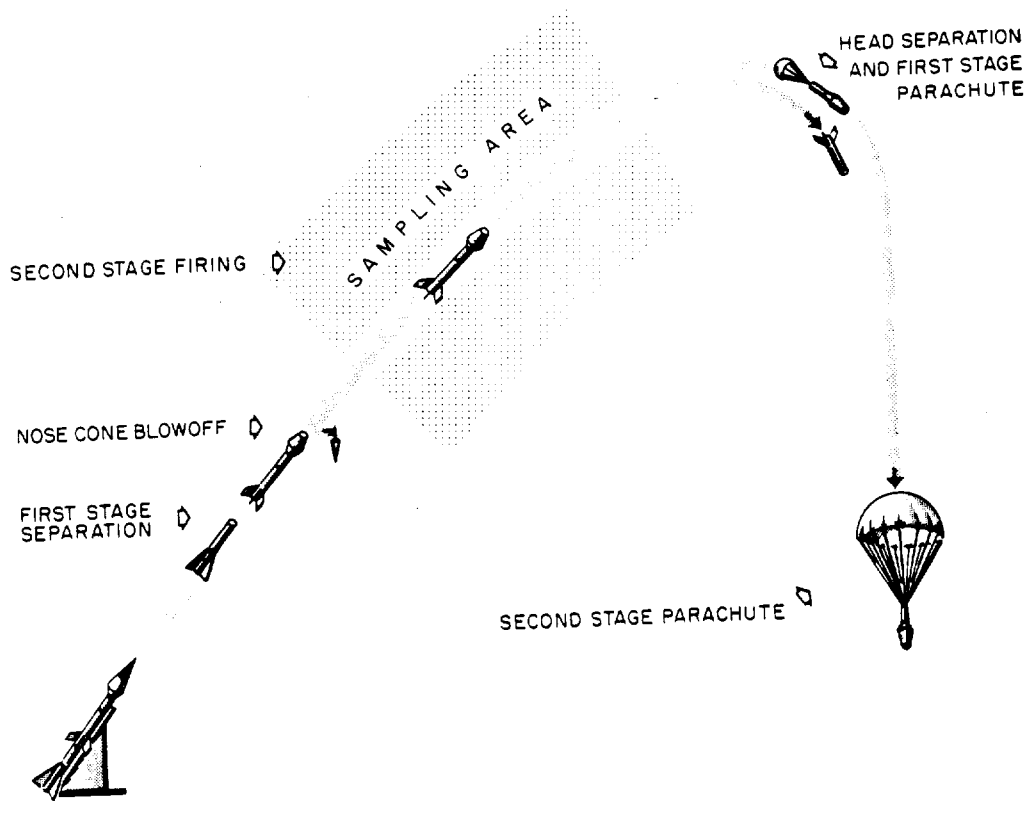

Figure A. 1 Diagram to Illustrate Rocket Programming

SAY BRUNO FRG

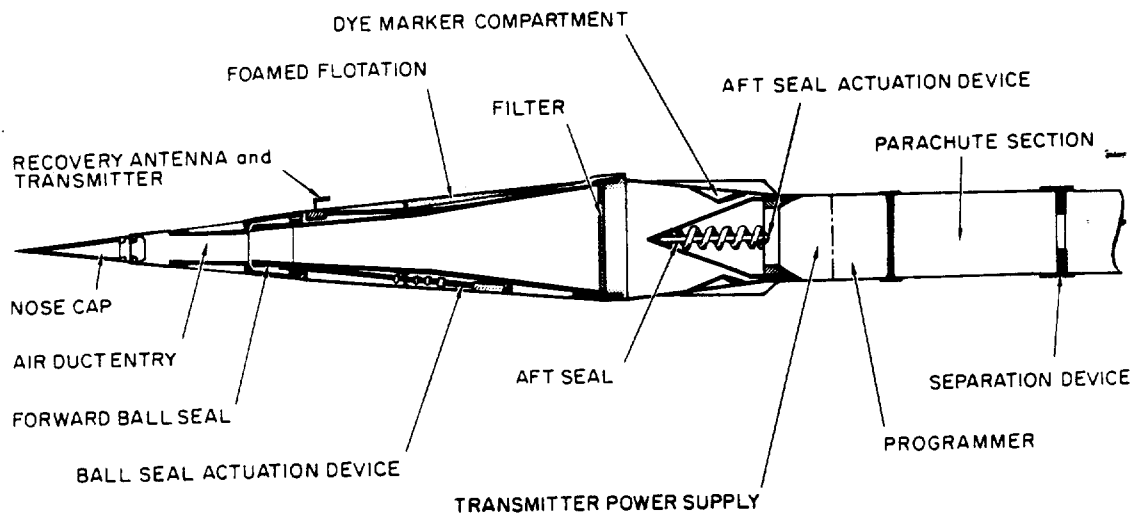

Figure A.2 Schematic View of Rocket Nose Section

SAN BRENDO 160

[REDACTED]

were subjected to environmental tests at North American Aviation Co. during the month of July. The tests included low temperature cycle, vibration and acceleration.

For the low temperature tests, the forward and aft seals were closed and the programmer and its container were removed. Thermocouples were placed on the "O-rings" of the forward and aft seals. The assembly was brought to room temperature (75 F°) and the cold chamber was stabilized at -65 F°. The nose cone was placed in the cold chamber and allowed to stand for five minutes. At the end of that time, the forward seal "O-ring" temperature was -10 F°. The nose cone was removed from the cold chamber and allowed to remain at room temperature for 4 minutes, then completely submerged in water for one minute and allowed to float at its normal level for 4 minutes. When the cone was removed from the water and disassembled, it was found that no leakage had occurred.

The cone used for the vibration test was a complete flight-ready-assembly except that the skin around the diffuser had been removed. The acceleration load was maintained at 5 g's while the vibration frequency was varied from 3 to 2000 cycles per second. The dwell time at each resonant frequency was one minute. The vibration was applied first in the plane parallel to the longitudinal center-line of the assembly, then in the plane perpendicular to the center-line. No failures occurred.

SAN BRUNO TRC

[REDACTED]

For the acceleration tests, a flight-ready nose cone assembly was separated into two sections at the filter joint. Both sections were placed on a spin table in the deceleration plane and the load was raised to 50 g's and held there for one minute. No failures occurred. The sections were then placed in the acceleration plane and the load was again increased to 50 g's and maintained at that level for one minute. The programmer started its functions at approximately 15 g's, continued to operate properly and no failures occurred. The test was then repeated using the nose cone which had been vibration tested and the results were the same. The four tests showed that the sampling cone design was entirely compatible with the anticipated environmental conditions.

Beginning on 17 July, further testing of possible sources of leakage in the sampling cones was conducted at the Morris Dam Small Calibre Range, Azusa, California, which is a facility of the U. S. Naval Ordnance Test Station, Pasadena, California. Ten assemblies were dropped into the water at various angles and with various modifications. The first 8 tests were carried out by dropping the assemblies from a height of approximately 32 feet at angles of 75° and 90° with the breathe hole left open. Other tests included drops of cones attached to parachutes from 100 feet, free-fall drops with the breathe hole closed, and parachute drops with a neoprene boot on the forward seal of the nose cones. The last 6 tests used

[REDACTED]

cones in which a vacuum (23 inches of mercury), similar to the near-vacuum of the upper atmosphere, had been induced. Examination of these assemblies after recovery showed that the vacuum remained when the breathe hole was sealed.

A total of 27 tests using 10 nose cone assemblies were conducted over a 5-day period. This work, plus further testing at the Cooper Development Corporation plant, indicated that certain points around the forward ball-seal joint and the operating mechanism were susceptible to small leaks as the pressure difference between the interior and exterior of the diffuser-filter section increased. The neoprene boot, which covered the operating mechanism, had proved to be particularly vulnerable during the Pacific firings and later tests. The reliability of the seal was increased a great deal by redesign of the boot, and only infrequent minute leaks were observed after installation of the improved boots. These leaks were repaired as they occurred until the seal was tight enough to hold a pressure difference of 23 inches of mercury for 10 minutes.

Following the successful drop tests, two flight test rounds were fired at NAMTC, Point Mugu, California, on 24 July. The nose cones for these rounds were modified to incorporate the improvements which had been made during the tests at Morris Dam. All programmer function times were as planned and both rounds were judged to be quite successful. Their trajec-

SAN BRUNO ETC

[REDACTED]

tories were followed throughout the flights by range radar, enabling the impact points to be quickly located by radars on the search aircraft. The cones were then recovered by a rescue craft. One of them was completely dry and the second contained only a few ml. of water. When the cones were disassembled, it was observed that the dry one had maintained a partial vacuum while the other had apparently leaked air to equalize the pressure.

In spite of the success of the flight tests, it was felt that still further improvements could be made in sealing the diffuser-filter assembly. A conference was held in August between Cooper and UCRL personnel to investigate new approaches to the problem. After study of the design, it was concluded that moving the forward ball seal "O-ring" from the forward to aft side of the ball would eliminate several possible sources of leakage, although there would be some sacrifice of performance. Slight leakage had been observed during some of the tests at the rubber boot on the push-pull rod, around the nose cap cable entries and at the forward nose cap blow-off joint. Relocation of the "O-ring" to a position aft of these areas was expected to prevent any water which might enter from reaching the filter. All changes in design which had been made at the EPG and later, including the relocation of the "O-ring", were incorporated in a new set of drawings and two new nose cones were manufactured to the revised draw-

ings.

A new antenna system was devised for the recovery transmitter consisting of two bent dipoles located on opposite sides of the head and positioned as far forward as possible so that they would be above the surface of the water. This system was tested at Puddingstone Dam near Pomona, California on 20 November 1958. The antenna was first submerged, then the head was allowed to float during the test. Readable signals were received as far as 5 miles away with both ground and aircraft receivers. The signal was both stronger and steadier than that produced by the antennas used on the Pacific rounds.

Drop tests using the two redesigned nose cones were conducted at Morris Dam on 22 November 1958. The assemblies were dropped 5 times each from a height of 35 feet. No parachutes were used and the angle of impact was not controlled. Both assemblies remained completely dry on the inside throughout the tests. One cone was slightly damaged when it came to the surface under a steel barge, but this was quickly repaired.

The two new nose cones were assembled into flight rounds for tests at NAMTC, Point Mugu, on 2 December 1958. Both rounds were launched at a 75° elevation angle and azimuth of 217° . The second stage of the first round either failed to ignite, or ignited only partially, as evidenced by the lack of a contrail and the horizontal range of only 14,200 yards. Nose cone

[REDACTED]

separation and parachute deployment were achieved satisfactorily. The nose cone was located after impact by a very strong, steady, directional signal from the recovery transmitter and by sighting the dye marker. It was completely dry inside and a vacuum seal had been maintained for 2-1/2 hours. On the next round, second stage ignition was observed and the range radar showed nose cone separation at approximately 105,000 feet. The payload descended very rapidly and could not be located by the search craft. The radar plots gave no indication as to the nature of the malfunction which evidently occurred. It is possible that the second stage parachute failed to deploy or that the first stage parachute was fouled by the motor.

These were the final tests carried out in the development of an ocean recovery version of the cloud sampling rocket. The results indicate that the improvements in design made subsequent to the field operation have resulted in a more practical system than the one available in April, 1958. However, further flight testing would be desirable if the rocket is to be used in a future cloud sampling program.

SAN BRUNO ERC

~~CONFIDENTIAL~~

APPENDIX B
RADIOCHEMICAL DATA TABLES

The tables given in this section (B. 1 through B. 6) contain a compilation of radiochemical data for all the samples collected by Project aircraft. The samplers are identified by the number or name of the sampling plane. The letters R or L placed next to the aircraft number (or name) indicate that sampling units toward the right or left side of the aircraft were used. The single rocket sample obtained is also included. The analytical results are tabulated separately for the gas and particulate samples from the three shots. Data on the particulate material is divided into three groups, namely gross cloud samples, size-separated cloud samples and fallout samples. In each table the data are arranged in the order of increasing time of collection.

The following general remarks will serve to clarify certain entries in the tables:-

1. All fission values based on Mo^{99} in the particulate sample tabulations have been normalized to a LASL K factor of 2.50×10^5 .

DELETED

SAN BRUNO F

DELETED

6. All Sr^{89} and Sr^{90} R values have been normalized to the LASL values by means of the KOA samples analyzed at both LASL and NRDL.

7. All Y^{91} R values have been normalized to the NRDL values by means of the KOA samples analyzed at both LASL and NRDL.

8. The term "probe velocity" refers to the pumping speed in the gas-particle coincident sampler. Samples collected at a low probe velocity may be suspected of being biased with respect to particle size.

9. On KOA the Massive samples were collected on the 60,000 foot height line; the Wilson Special sample was from the general fallout.

10. The fine fractions for the KOA and OAK size-separated samples were expected to contain a large proportion of particles having fall rates less than 1 cm./sec. Nominal falling rates for the WALNUT fractions were: fine fraction, less than 0.1 cm./sec.; medium fraction, 0.1 - 1.0 cm./sec.; coarse fraction, greater than 1 cm./sec.

11. The sampling altitudes given for Aircraft 978 on WALNUT and 981 on OAK are thought to be too high, but more reliable figures are not available.

SAN BRUNO FRC

0018953

TABLE B1

KOA PARTICULATE SAMPLES

DELETED

0-37
M/f

En-156
R

Ce-144
R

Ce-137
R

Ce-136
R

Y91
R

Sr-89
R

Ca-145
10⁴ M/f

fission
Mo-99

10⁻¹²

Gross Particulate Samples

Analysis by

LASL
NRDL

LASL
NRDL

LASL
NRDL

LASL
NRDL

LASL
NRDL

LASL
NRDL

LASL
NRDL

LASL
NRDL

LASL
NRDL

LASL
NRDL

Aircraft	Time (hrs)	Altitude (ft)	Sample Type	fission x 10 ⁻¹²	Ca-145 10 ⁴ M/f	Sr-89 R	Y91 R	Ce-136 R	Ce-137 R	Ce-144 R	En-156 R	0-37 M/f	Analysis by
502	2.3	40000	Gross, LASL 'A'										LASL NRDL
500	2.75	45000	Gross, LASL 'A'										LASL NRDL
569	3.0	49000	Gross, LASL 'A'										LASL NRDL
977	4.5	60600	Gross, LASL 'A'										LASL NRDL
981 L	6.5	56000	Gross, LASL 'A'										LASL NRDL
981 R	7.3	60000	Gross, LASL 'A'										LASL NRDL
502	3	39000	fine coarse										NRDL, UCRL NRDL, UCRL
500	3.5	45000	fine coarse										NRDL, UCRL NRDL, UCRL
977	4.5	60600	fine coarse										NRDL, UCRL NRDL
981 L	6.5	56000	fine coarse										NRDL NRDL
981 R	8	60000	fine coarse										NRDL NRDL
980 L	11	60000	fine coarse										NRDL NRDL
Massive L1	4	1000	Gross, B-50										NRDL
Massive R2	6	1000	Gross, B-50										NRDL
Massive R3	8	1000	Gross, B-50										NRDL
Massive R4	10	1000	Gross, B-50										NRDL
Massive R5	12	1000	Gross, B-50										NRDL
Wilson Spl. R 6 Device	6	1000	Gross, B-50										NRDL, UCRL NRDL, UCRL

DELETED

SAN BRUNO FIELD

TABLE B2
KOA GAS SAMPLES

Aircraft & side	Time (hrs)	Altitude (ft)	Probe v Aircraft v	Remarks	$\text{fission}_{\text{Kr}^{86}} \times 10^{-11}$	$\text{fission}_{\text{Kr}^{85}} \times 10^{-11}$	$\text{fission}_{\text{Kr}^{85}} \times 10^{-11}$	Analysis by
502 R	2.5	41000	0.10	Low probe velocity				UCRL
500 L	3.5	47000	0.58					UCRL
500 R	"	"	0.69	No Kr done. Value from Xe-133				UCRL
977 R	3.75	61500	-					UCRL
981 R	6.5	57000	0.66					UCRL

DELETED

SAN BRUNO FRC



0018455

TABLE B*

WALNUT PARTICULATE SAMPLES

Aircraft	Time (hrs)	Altitude (ft)	Sample Type	fissions x 10 ⁻¹² Mo ⁹⁹	Ca ⁴⁵ /10 ⁴ f	Sr ⁸⁹ R	St ⁹⁰ R	Y ⁹¹ R	Ca ¹³⁶ R	Cs ¹³⁷ R	Ce ¹⁴⁴ R	Ba ¹⁵⁶ R	U ²³⁴ M/f	Ke mg/10 ¹² f	Analysis by
982	1.6	57,500	Gross, LASL 'A'												LASL
501	2.5	42,000	Gross, LASL 'A'												LASL
504	3.1	44,000	Gross, LASL 'A'												LASL
496	3.15	48,000	Gross, LASL 'A'												LASL
980	3.4	58,000	Gross, LASL 'A'												LASL
500	3.7	50,000	Gross, LASL 'A'												LASL
978	6.8	64,000	Gross, LASL 'A'												LASL
981	12.3	57,800	Gross, LASL 'A'												LASL
978	27.5	58,500	Gross, LASL 'A'												LASL
982	1.5	57,000	fine medium coarse												NRDL NRDL NRDL
980	3.4	58,000	Gross												NRDL
978	28.	58,500	fine medium coarse												NRDL NRDL NRDL
Whiskey 6	-	-	Gross, rocket												NRDL
Massive 1 R1 4		1000	Gross, B-50												NRDL
Massive 2 R1 10		1000	Gross, B-50												NRDL
Massive 2 R2 13		1000	Gross, B-50												NRDL

Gross Particulate Samples

DELETED

SAN BRUNO FRC

BEST COPY AVAILABLE



0018433

TABLE B4
VALNUT GAS SAMPLES

Aircraft & side	Time (hrs)	Altitude (ft)	Probe, V Aircraft V	Remarks	fissions x 10 ⁻¹¹ Kr 85	fissions x 10 ⁻¹¹ Kr 85	fissions x 10 ⁻¹¹ Kr 85	Analysis by
982 L	1.6	58000	0.89					UCRL
501 L	2.5	42000	1.29					UCRL
504 L	3.1	44000	0.81					UCRL
504 R	"	"	0.73					UCRL
496 L	3.15	48000	0.79					UCRL
496 R	"	"	0.65					UCRL
980 L	3.4	58000	0.76					UCRL
980 R	"	"	0.87					UCRL
500 R	3.7	50000	0.86					UCRL
978 L	6.8	64000	0.74					UCRL
978 R	"	"	0.79					UCRL
981 L	12.3	57800	0.71					UCRL
978 L	27.5	58500	0.26	Low probe velocity				UCRL

DELETED

SAN BRUNO FRC

0018933

TABLE B5
OAK PARTICULATE SAMPLES

Aircraft	Time (hrs)	Altitude (ft)	Sample Type	fissions x 10 ⁻¹² Mo99	Ca ⁴⁵ /10 ¹² f	Sr ⁸⁹ R	Sr ⁹⁰ R	Y ⁹¹ R	Co ¹³⁶ R	Co ¹³⁷ R	Co ¹⁴⁴ R	Eu ¹⁵⁶ R	U ²³⁷ W/f	Ca ²⁴² d/m/10 ¹² f	Ca ^{Na} 10 ¹² mg/10 ¹² f	Analysis by
					Gross Particulate Samples											
978	2.1	56000	Gross, LASL 'A'													LASL
504	2.8	47000	Gross, LASL 'A'													LASL
981	3.2	67500	Gross, LASL 'A'													LASL
496	3.25	49000	Gross, LASL 'A'													LASL
495	3.75	54000	Gross, LASL 'A'													LASL
501	3.9	44500	Gross, LASL 'A'													LASL
982	6.0	56300	Gross, LASL 'A'													LASL
980	12.3	56300	Gross, LASL 'A'													LASL
977	26.8	55500	Gross, LASL 'A'													LASL
978	2.1	55300	fine coarse													WRDL WRDL
977	26.8	55500	fine coarse													WRDL WRDL
Massive B1	4	1000	Gross, B-50													WRDL
Massive B2	6	1000	Gross, B-50													WRDL
Massive B3	8	1000	Gross, B-50													WRDL
Massive B4	10	1000	Gross, B-50													WRDL
Massive B5	12	1000	Gross, B-50													WRDL
Device																

DELETED

N BRUNO ETC



0018933

TABLE B6
OAK GAS SAMPLES

Aircraft & side	Time (hrs)	Altitude (ft)	Probe V Aircraft v	Remarks	fissions x 10 ⁻¹¹ Mo ⁹⁹	fissions x 10 ⁻¹¹ Kr ^{85m}	fissions x 10 ⁻¹¹ Kr ⁸⁵	Analysis by
978 L	2.1	56400	0.90					UCRL
504 L	2.8	47000	0.94					UCRL
504 R	"	"	0.82					UCRL
981 R	3.2	65500	0.53					UCRL
496 L	3.25	49000	0.72					UCRL
496 R	"	"	0.63					UCRL
495 L	3.75	54000	0.68					UCRL
501 L	3.9	45500	0.76					UCRL
501 R	"	"	0.61					UCRL
982 L	6.0	56300	0.49					UCRL
982 R	"	"	0.67					UCRL
980 L	9.5	56300	0.18	Low probe velocity				UCRL
980 R	12.3	56300	0.70					UCRL
977 R	26.8	55500	0.70					UCRL

~~DELETED~~

SAN BRUNO FIC

APPENDIX CPARTICLE DATA AND CHARACTERISTICS, SHOT KOA

C. 1 Size Distribution, Fall Rate and Specific Activity Data

Fall rate distribution data, particle size data and specific activity-fall rate data are presented in graphical form, in Figures C. 1 through C. 13, for the cloud and fallout samples listed in Table C. 1. Samples 500, 502 and 977 from the cloud were separated into coarse and fine fractions with the Bahco centrifuge before determination of the distribution curves. The boundary between the centrifuge fractions is as given in Appendix B. No fall rate work was done on samples taken from the cloud at times later than four hours due to the small quantity of material collected.

TABLE C. 1Sample List

<u>Fall Rate Distribution</u>	<u>Particle Size Distribution</u>	<u>Specific Activity</u>
Massive L1	Massive L1	Massive L5
Massive L2	Massive L4	Wilson Special
Massive L3	502 Coarse	502 Coarse
Massive L4	502 Fine	502 Fine
Massive L5	500 Coarse	500 Coarse
Wilson Special	500 Fine	500 Fine
502 Coarse	977 Coarse	977 Coarse
502 Fine	977 Fine	977 Fine
500 Coarse		
500 Fine		
977 Coarse		
977 Fine		

These results are being reported primarily for record purposes.

C2. Particle Characteristics

The majority of the particles were translucent white and had an irregular shape. Some flaky aggregates, small spheres apparently formed by condensation, and clusters of varying sizes were also present. Many of the larger particles were discolored with a reddish-brown stain, presumably due to iron oxide.

The main constituents were identified as $\text{Ca}(\text{OH})_2$ and CaCO_3 (both calcite and aragonite) by examination with polarized light and by X-ray-diffraction. Small quantities of ocean water salts were observed in all the samples.

The particles disintegrated spontaneously into many small fragments when brought into contact with liquids. The disintegration was most rapid with water, but also occurred at a slower rate with hydrocarbons and other fluids. Due to this effect, their density could not be determined by the brombenzene-bromoform method.

Size measurement and type classification were described in Section 2.4; this investigation is summarized in Table C.2.

SAN BRUNO

TABLE C.2Particle Classification and Size Measurements

Sample	No. of Particles Measured	Mean Size, Microns	Particle Type, %		
			Irregular	Aggregates	Spheres
Massive L1	115	155	67.3	18.5	14.1
Massive L4	216	65	51.4	16.2	32.4
502 Coarse	255	48	82.0	11.0	7.0
502 Fine	287	19	93.7	3.5	2.8
500 Coarse	331	46	63.7	2.3	29.0
500 Fine	619	24	94.0	3.1	2.9
977 Coarse	264	47	76.1	9.5	14.4
977 Fine	299	21	94.6	2.3	3.1

SAN BRUNO ERG

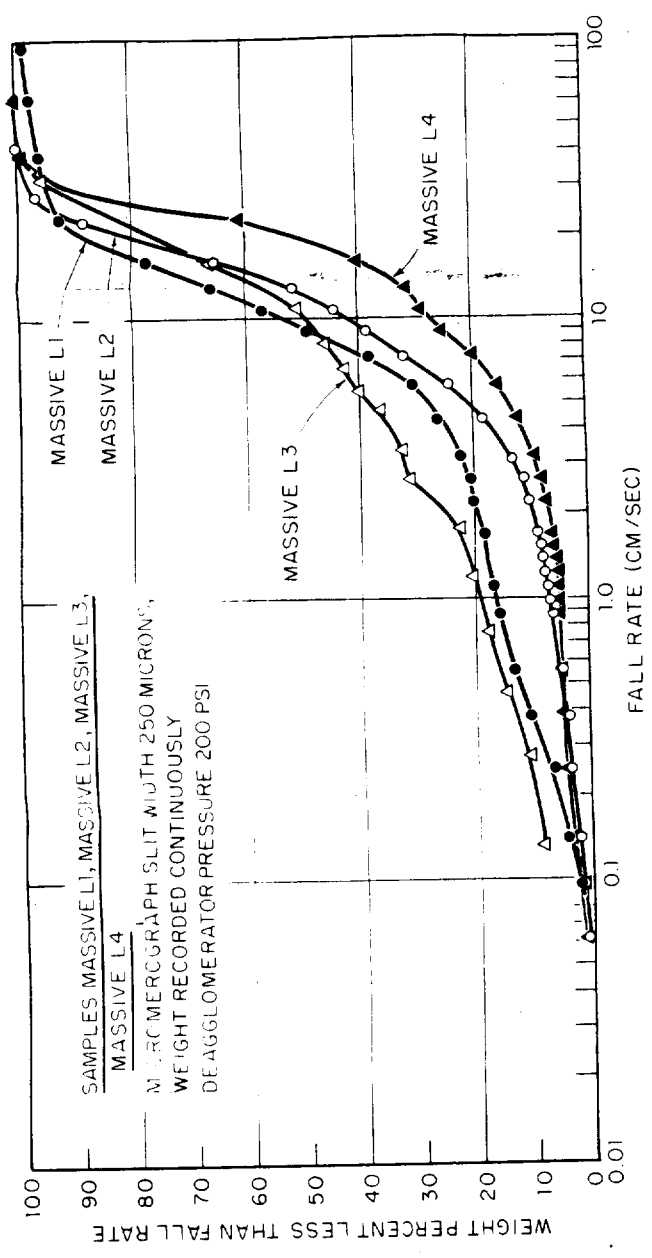

SAN BERNARDINO

Fig 2
UNCLASSIFIED

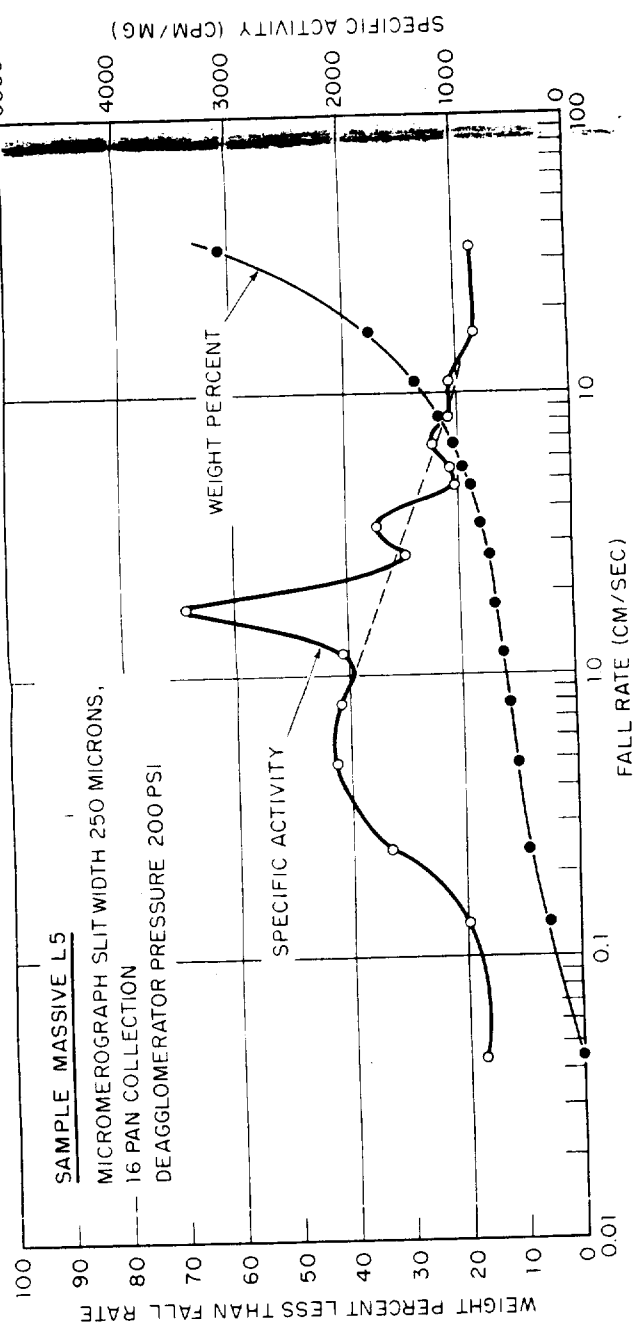

SAMPLE MASSIVE L5
MICROMEROGRAF SLIT WIDTH 250 MICRONS,
16 PAN COLLECTION
DEAGGLOMERATOR PRESSURE 200 PSI

SAN BRUNO ERC

FIG. 2
10/27/55

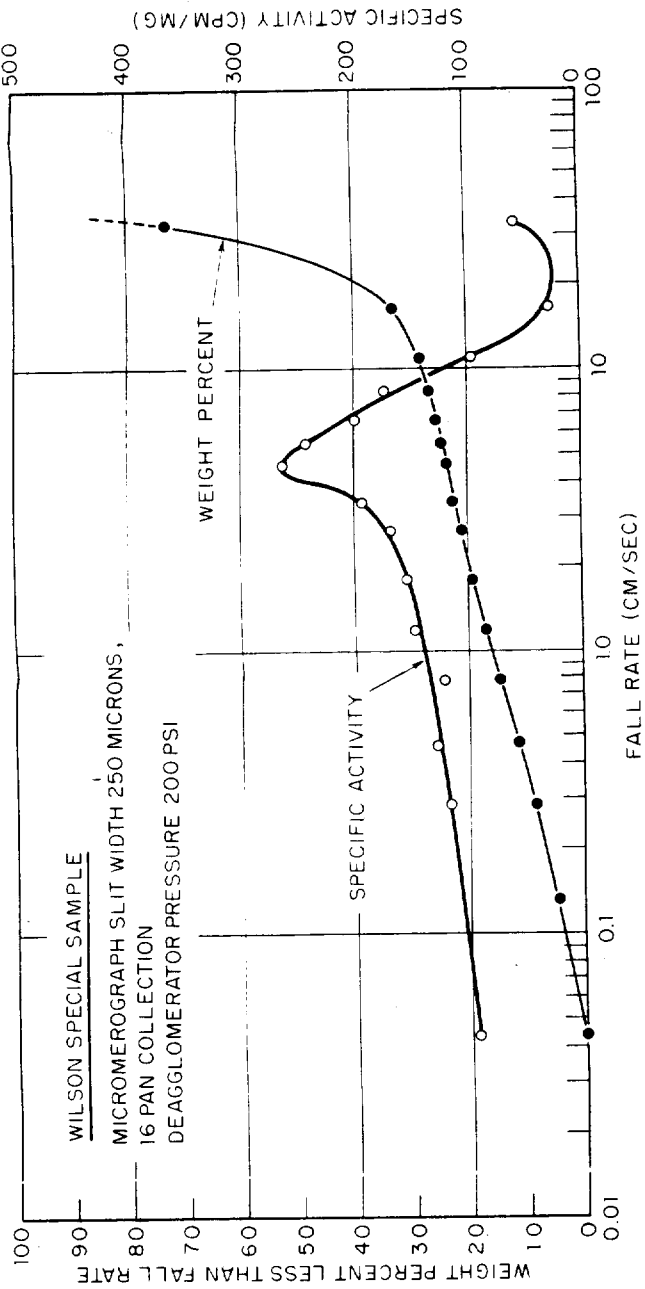

SAN BRUNO ERG

UNCLASSIFIED

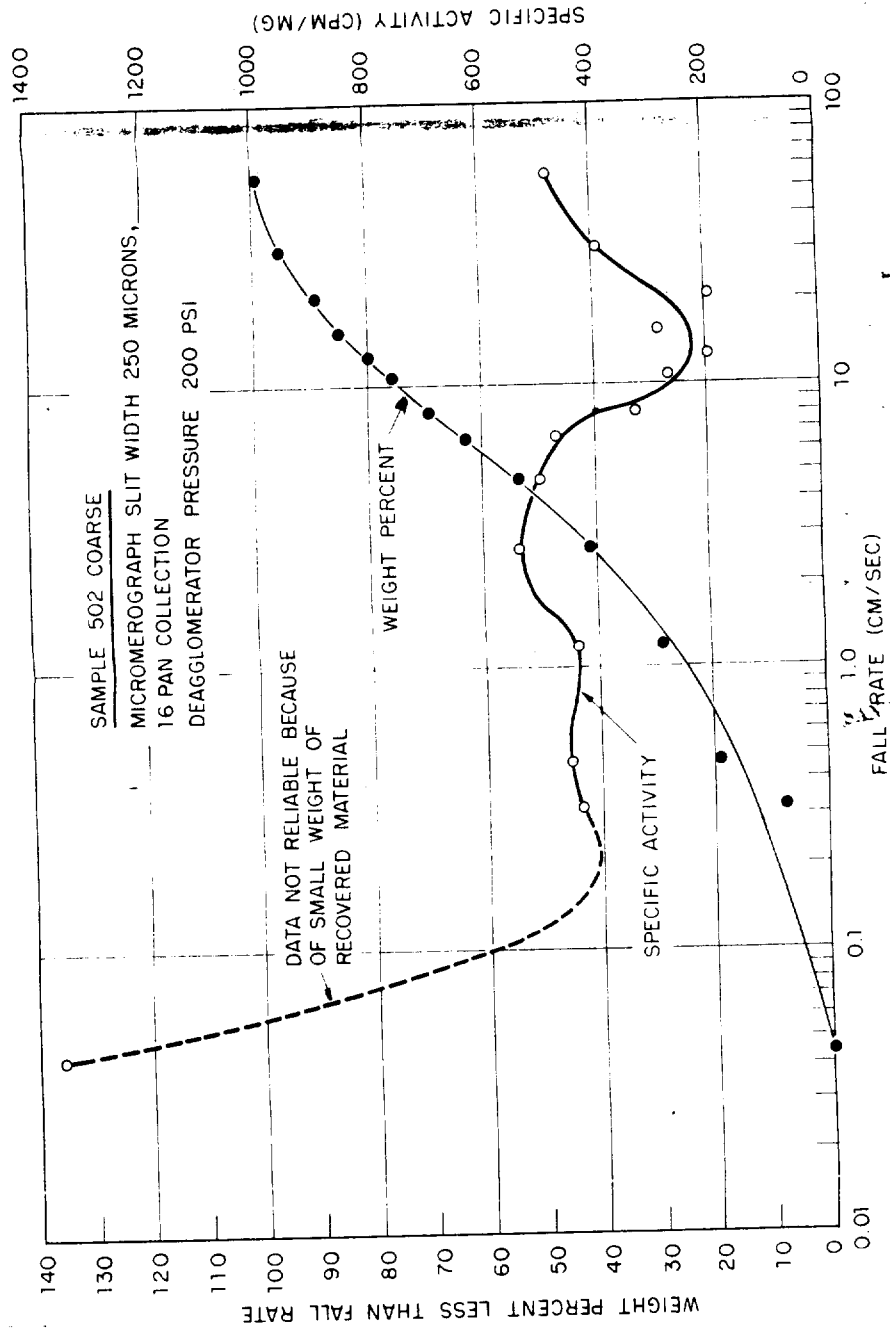

UNCLASSIFIED

FIG. 4

UNCLASSIFIED

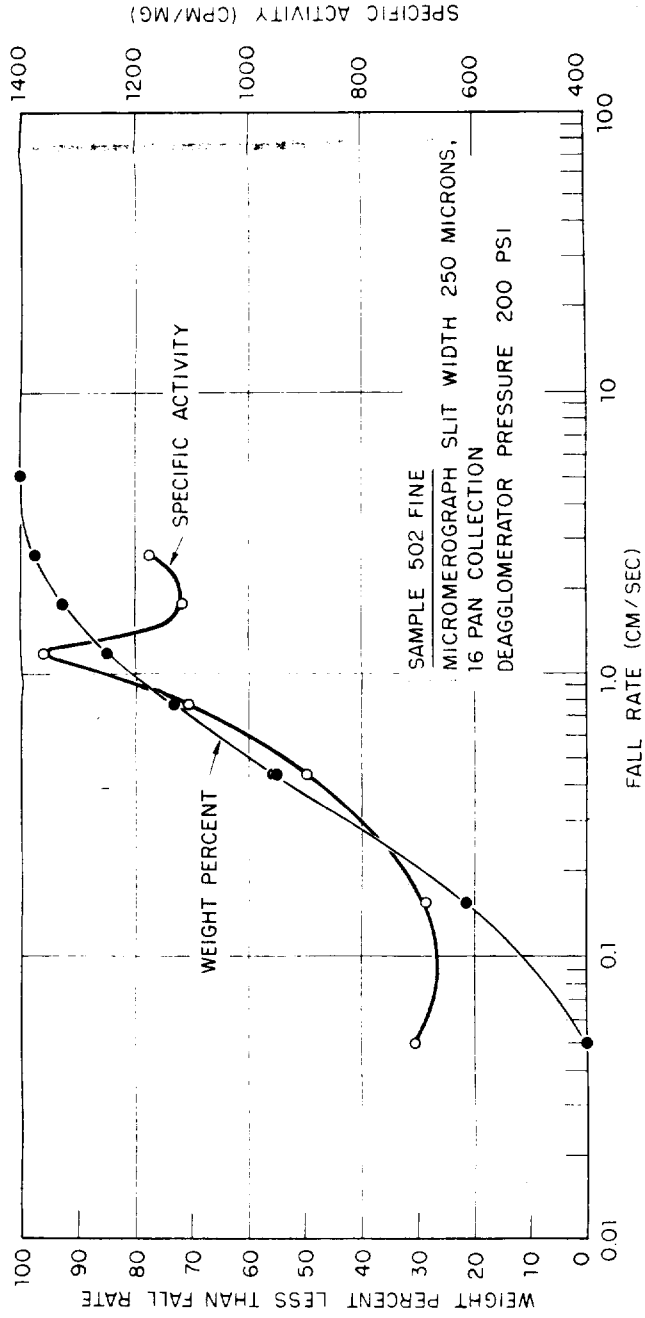
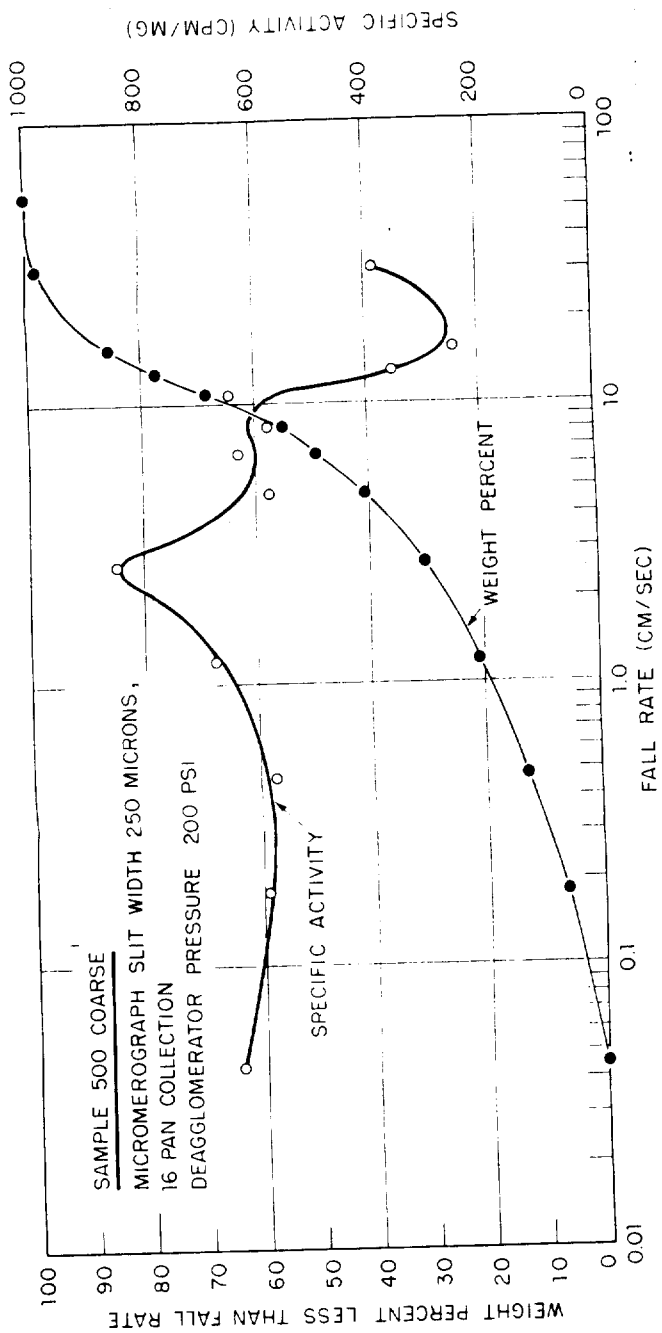

FIG. 10
UNCLASSIFIED

NAV BRL NO 178



SAN BRNO FIG

FIG. 2.6
UNCLASSIFIED

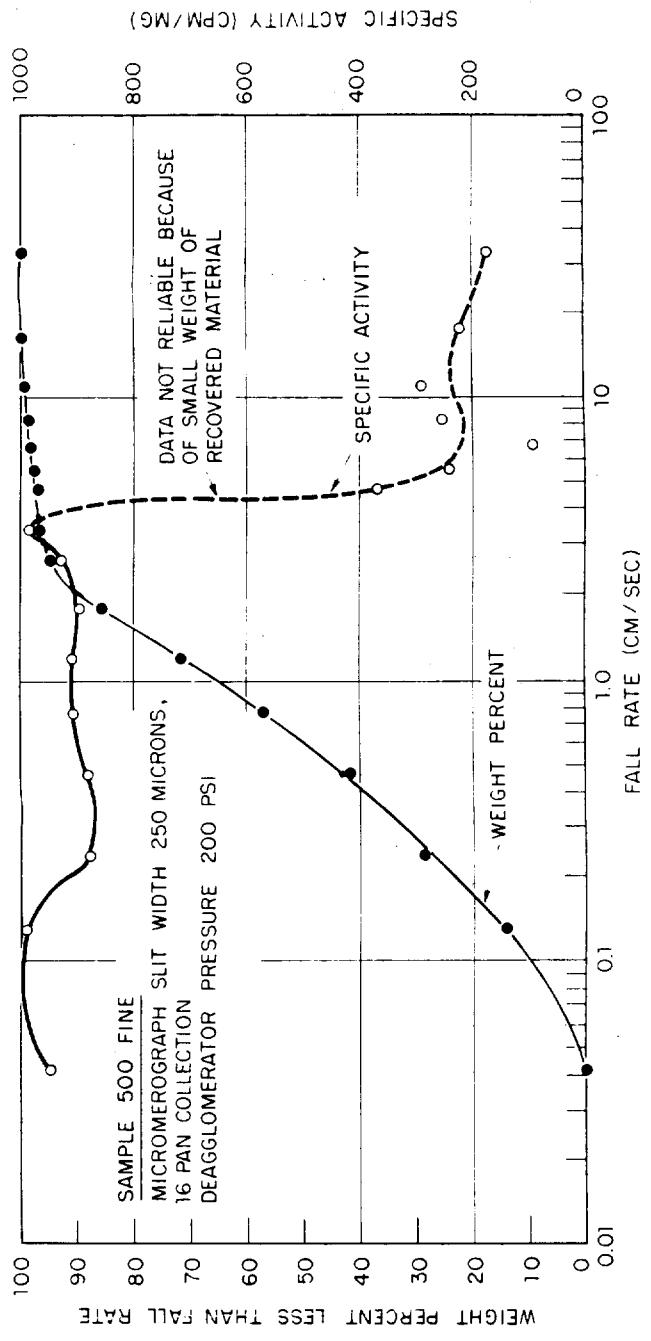

SAN BRUNO ERG

FIG 07

LD

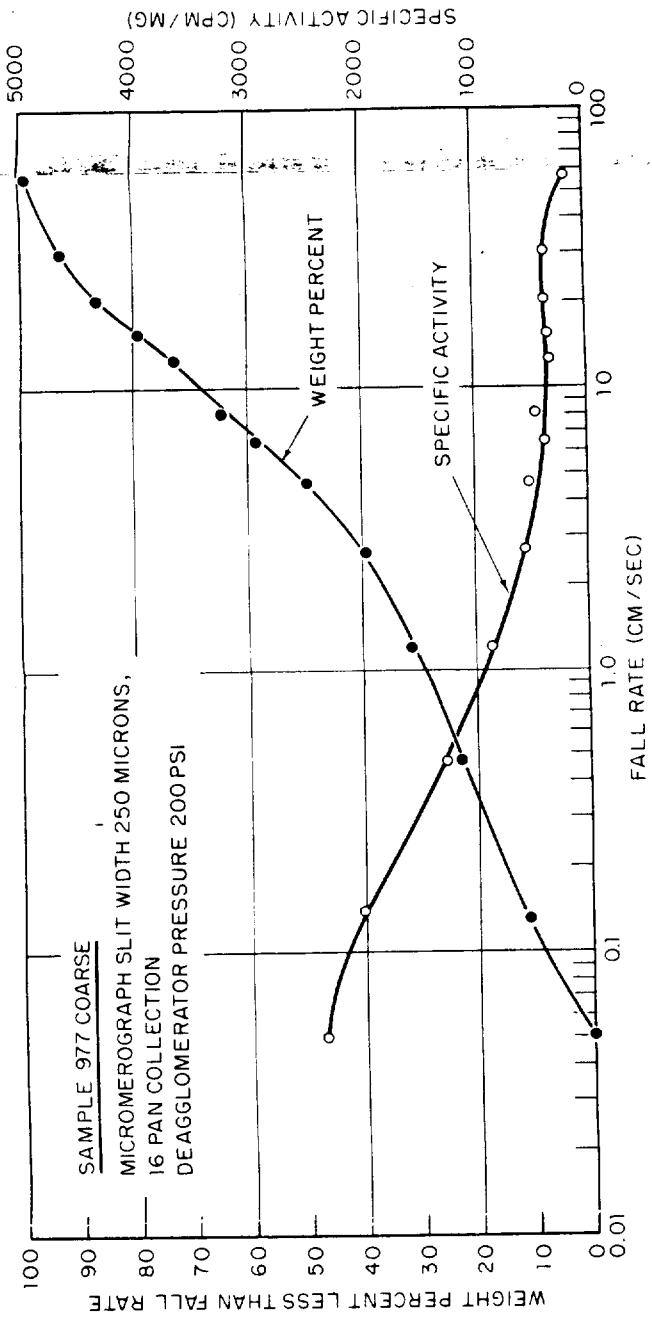

SAN BRUNO ERG

FIG. 45

1 26

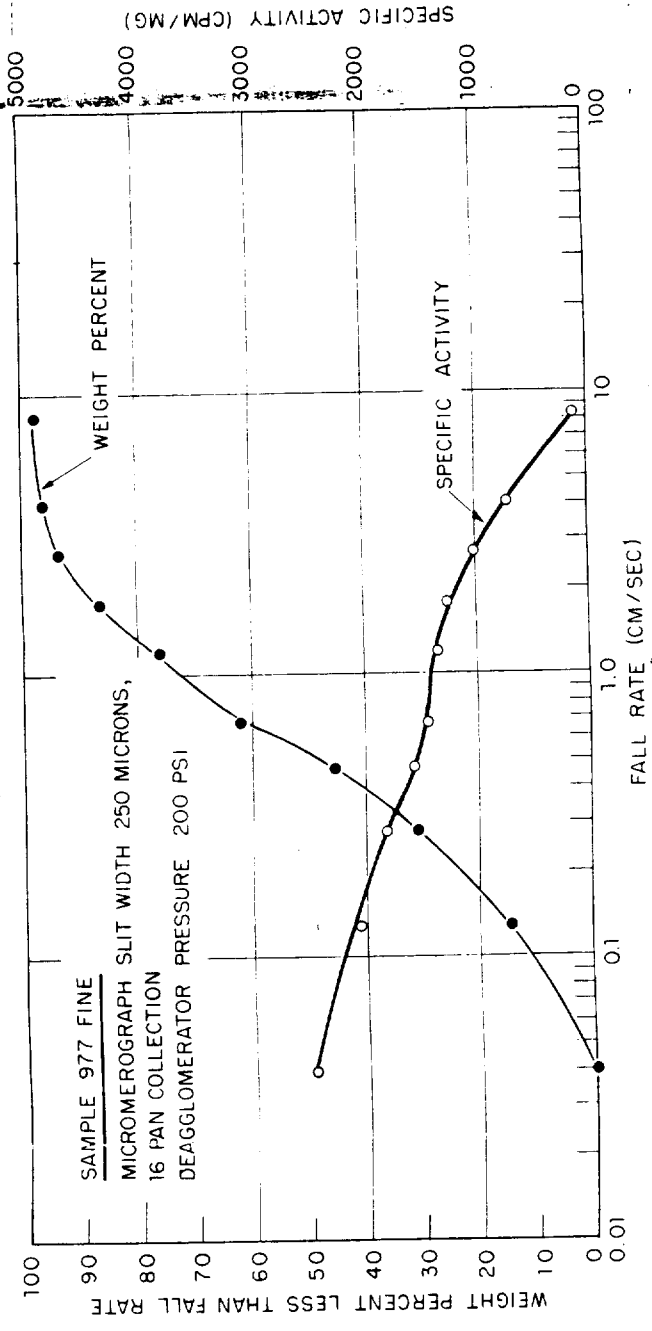

SAY BRLNO ERG

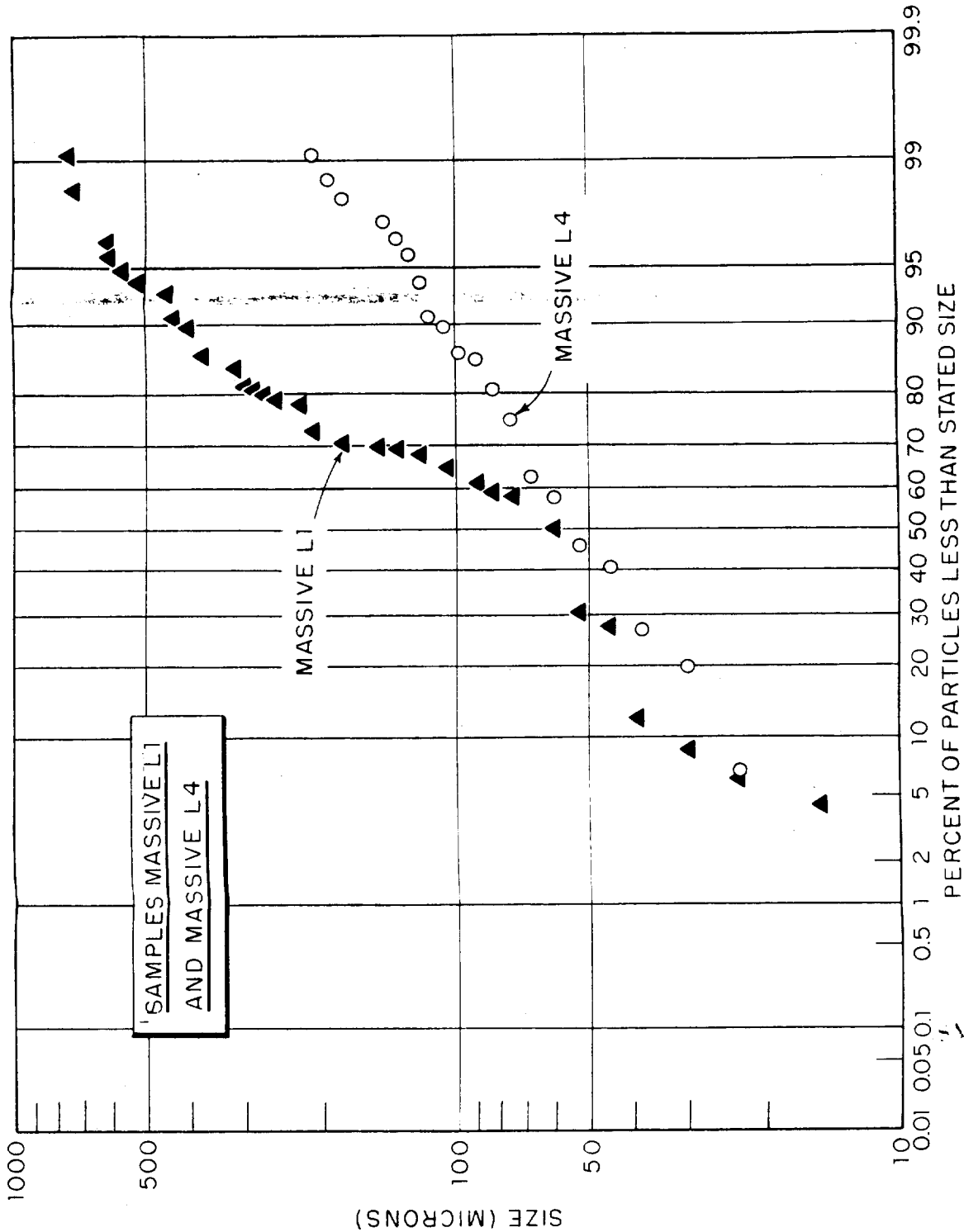

104

RAY BRUNO INC

128

FIG. 2/10

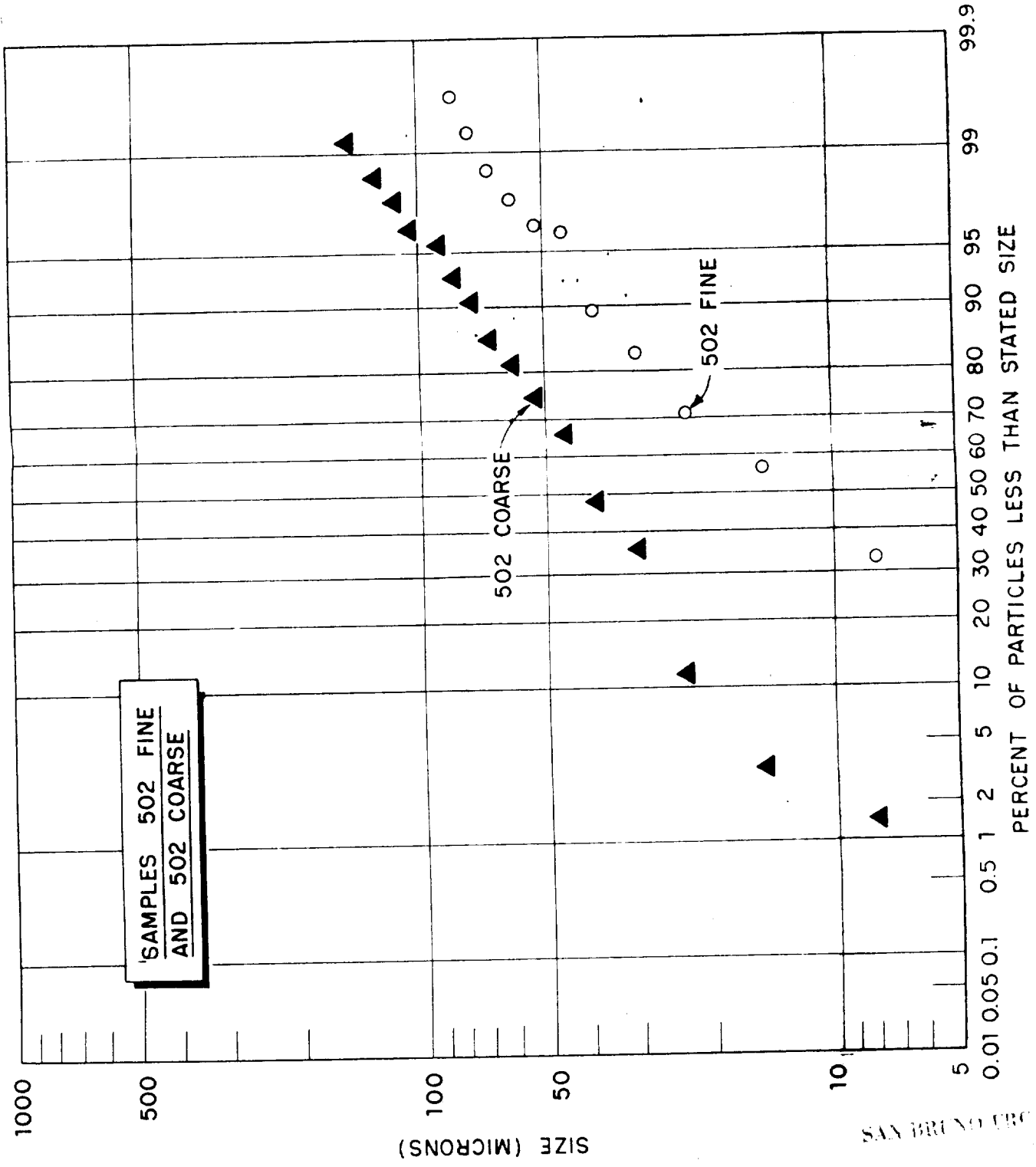

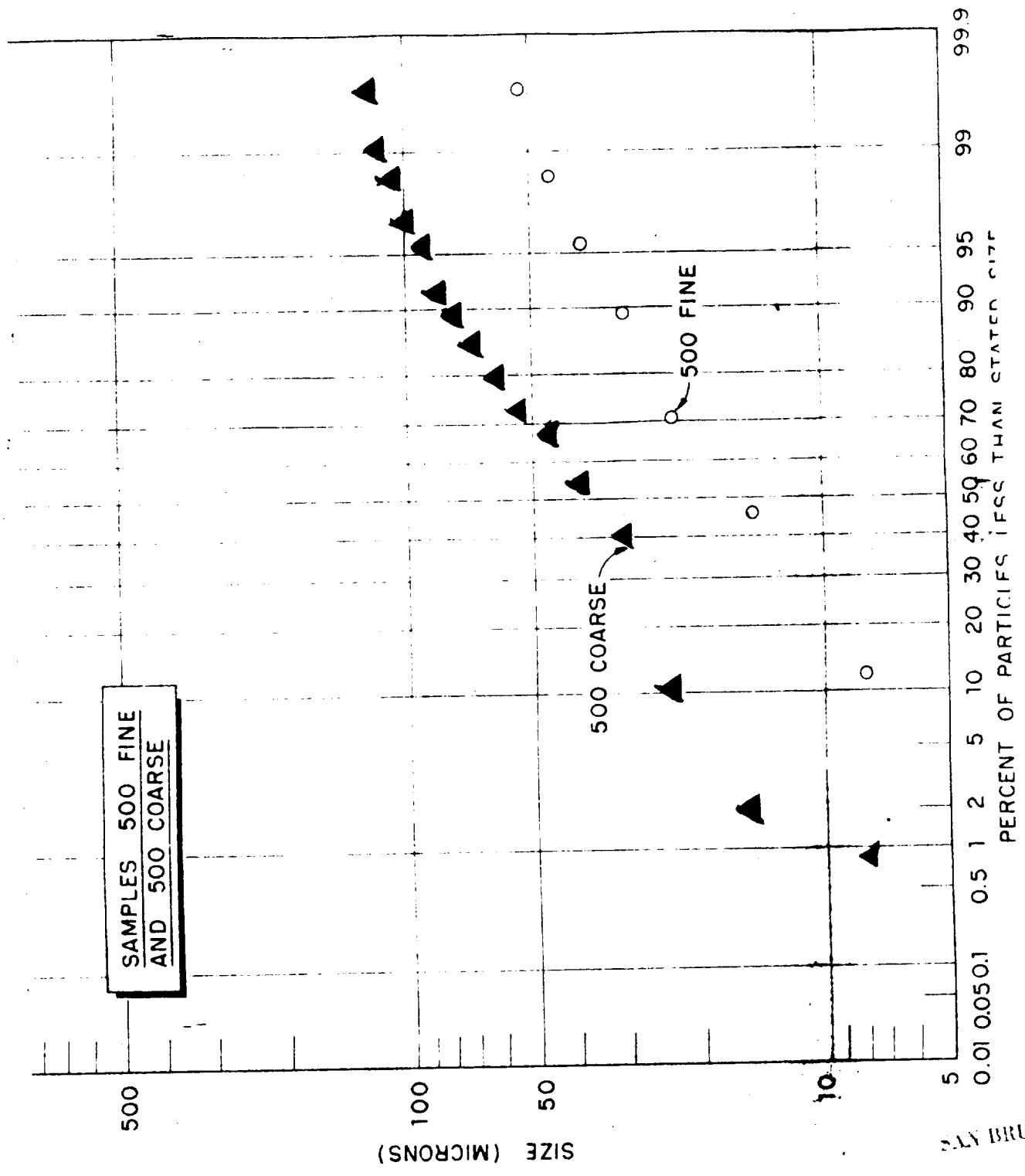

RAY BRUNO ETC.

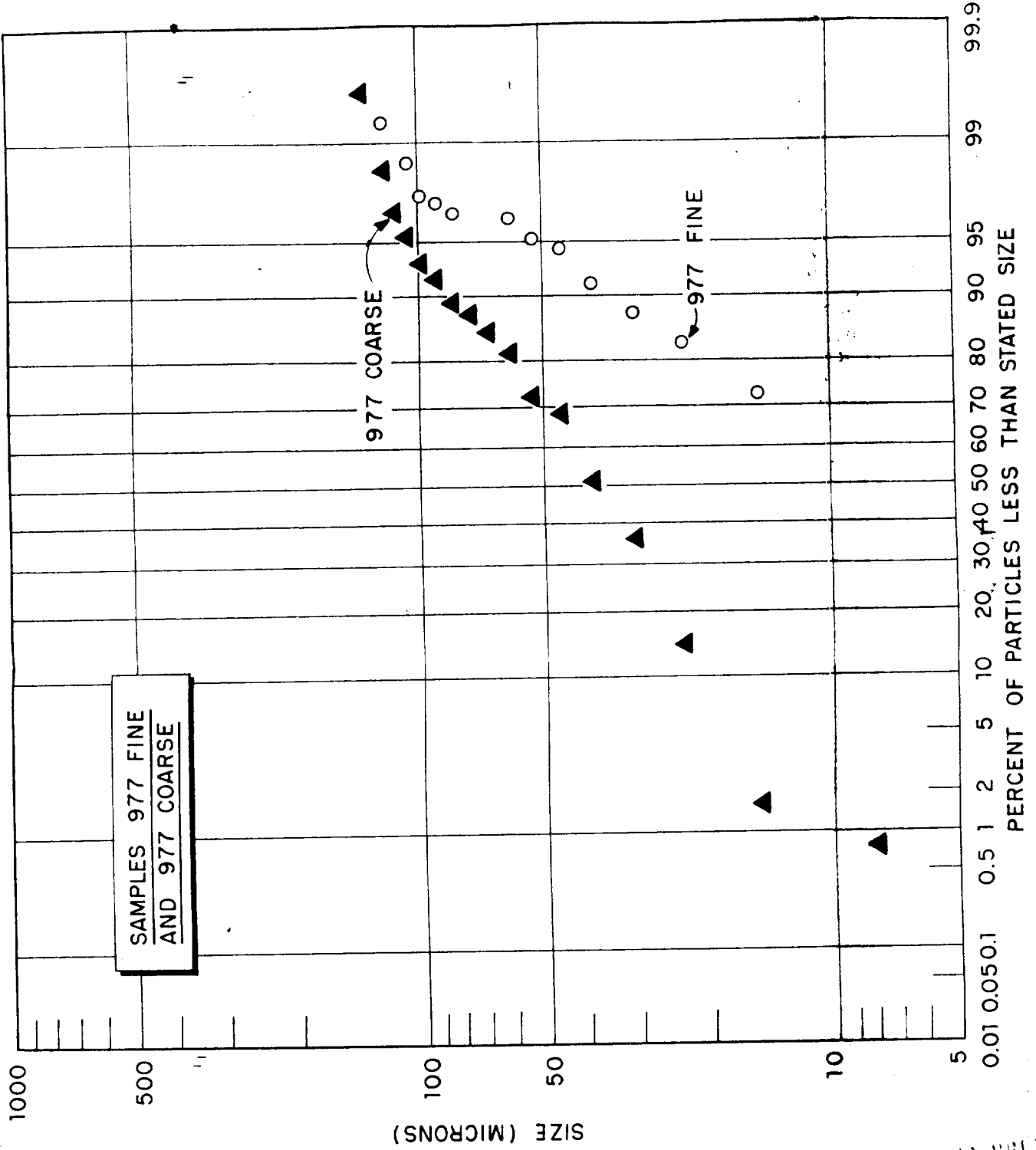

SUNBELT CO. INC.

APPENDIX D
METEOROLOGICAL DATA TABLES

Meteorological data for the shot days of Koa, Walnut and Oak are presented. Tables D-1 through D-3 give winds aloft, while Tables D-4 through D-6 give atmospheric temperature data.

SAN FRANCISCO

TABLE D.1

Winds Aloft Data, 13-14 May 1958

Alt., ft. x 10 ³	H - 1/2		H + 5/8		H + 8/8		H + 11/8		H + 17/8		H + 23/8		H + 28/8	
	DD	FFF	DD	FFF	DD	FFF	DD	FFF	DD	FFF	DD	FFF	DD	FFF
1	07	025	08	028	09	023	08	023	08	023	06	021	07	021
2	07	027	07	033	09	030	08	025	09	024	06	023	08	023
3	08	028	07	032	09	030	08	026	09	026	08	023	08	021
4	08	031	08	025	09	030	09	027	09	027	08	022	09	017
5	09	029	08	025	09	026	10	023	09	025	09	024	09	016
6	10	025	09	020	09	022	11	023	09	022	09	027	09	020
7	10	027	10	016	08	019	10	023	09	021	09	023	10	021
8	10	027	10	017	09	016	08	019	09	019	09	015	10	014
9	09	022	10	017	09	010	07	017	09	012	09	012	10	009
10	09	022	12	016	10	022	09	012	09	008	05	009	10	005
12	10	025	13	017	09	015	12	011	09	006	02	004	29	003
14	11	022	15	012	12	009	12	004	09	004	20	004	25	002
16	12	012	14	012	11	008	19	010	---	---	23	004	30	003
18	11	010	14	012	15	009	18	004	33	007	21	004	31	008
20	07	007	13	004	15	008	22	008	27	010	24	010	28	004
23	20	008	18	016	16	014	18	014	24	009	27	013	29	006
25	27	012	16	016	16	019	12	012	22	012	28	017	30	016
30	25	021	24	018	15	020	25	019	22	018	25	014	27	015
35	19	027	17	027	17	025	17	018	20	024	24	016	25	020
40	22	025	19	025	22	020	23	027	22	023	24	022	23	030
45	24	035	26	045	25	039	24	034	25	023	29	021	26	025
50	29	031	28	030	28	027	28	029	27	025	27	026	27	022
55	28	011	23	012	19	019	20	028	23	022	24	029	28	020
60	14	015	21	006	24	006	27	010	30	008	35	013	02	012
65	09	006	06	007	06	009	04	011	04	004	07	007	06	007
70	10	014	13	008	06	005	15	006	06	010	07	012	09	012
75	10	020	07	017	08	020	07	014	11	021	12	015	07	010
80	10	027	09	031	10	033	11	026	10	025	09	023	10	018
85	09	036	10	046	09	048	10	044	09	035	---	---	09	039
90	09	051	11	062	---	---	10	053	09	053	---	---	09	048

DD --- Wind bearing to nearest 10 degrees

FFF --- Wind speed, knots

SAN BRUNO ITC

TABLE D.2

Winds Aloft Data, 15 June 1958

Alt., ft. $\times 10^3$	H - $\frac{1}{2}$		H $\frac{1}{4}$ 2 $\frac{1}{2}$		H $\frac{1}{4}$ 5 $\frac{1}{8}$		H $\frac{1}{4}$ 8		H $\frac{1}{4}$ 11 $\frac{1}{8}$		H $\frac{1}{4}$ 17 $\frac{1}{8}$	
	DD	FFF	DD	FFF	DD	FFF	DD	FFF	DD	FFF	DD	FFF
1	07	010	09	020	10	015	04	004	08	016	07	018
2	08	019	08	019	08	017	07	021	07	018	08	022
3	07	019	09	019	10	017	08	018	08	018	09	023
4	09	019	11	019	10	017	09	018	09	018	10	023
5	09	017	11	019	10	016	10	017	09	021	10	022
6	09	013	11	018	11	018	11	017	09	023	10	020
7	09	013	11	017	11	018	11	018	09	028	10	020
8	09	013	11	014	11	015	10	015	10	017	10	020
9	10	013	11	014	11	012	11	013	10	014	10	019
10	10	013	11	014	10	013	12	012	12	015	10	017
12	09	010	11	011	12	009	10	011	09	010	11	012
14	11	015	09	009	11	007	12	007	11	006	12	006
16	11	020	10	013	13	010	10	008	11	008	14	011
18	11	020	11	016	12	019	12	010	12	013	12	010
20	11	018	13	011	13	017	13	014	12	012	10	011
23	15	016	14	008	11	006	13	012	13	012	10	012
25	20	011	17	006	13	006	12	016	14	016	11	014
30	18	025	15	012	16	012	16	020	17	021	12	014
35	18	021	19	019	16	025	18	018	18	019	17	014
40	21	023	18	025	16	024	18	014	17	024	17	028
45	18	014	18	015	16	023	16	024	17	039	17	037
50	19	014	18	024	18	026	15	033	18	008	21	021
55	11	008	14	014	17	005	19	035	05	013	12	016
60	08	017	00	013	08	015	14	004	09	017	09	015
65	10	023	--	----	11	026	--	----	--	----	07	019
70	09	025	--	----	09	024	--	----	08	029	09	031
75	09	042	--	----	09	034	--	----	--	----	10	049
80	09	050	--	----	09	046	--	----	09	015	10	050
85	09	060	--	----	09	060	--	----	--	----	09	058
90	09	064	--	----	10	066	--	----	08	047	09	065

SAN BRUNO TBC

TABLE D.3

WINDS ALOFT DATA, 29 JUNE 1958

Alt., ft. x 10 ³	H - 1-1/2		H + 1		H + 2-1/2		H + 4-1/2		H + 10-1/2		H + 12-1/2		H + 15-1/2	
	DD	FFF	DD	FFF	DD	FFF	DD	FFF	DD	FFF	DD	FFF	DD	FFF
1	09	019	09	019	08	020	08	015	09	021	09	022	10	011
2	09	015	10	021	09	019	08	019	10	026	09	027	10	023
3	10	015	10	021	09	019	08	019	10	024	09	026	10	023
4	11	015	10	021	10	019	09	017	10	022	09	026	10	022
5	11	018	11	019	10	018	10	017	11	017	10	020	10	025
6	10	018	11	017	10	015	11	015	10	014	10	023	09	025
7	10	016	12	017	12	013	12	015	10	016	11	019	09	023
8	11	016	12	017	13	010	13	015	10	017	11	017	10	019
9	11	016	13	016	14	011	13	015	10	015	11	018	10	014
10	11	016	14	015	15	013	13	015	10	011	11	015	10	015
12	11	014	15	014	19	013	13	016	11	014	12	011	10	011
14	11	013	13	016	15	015	15	019	13	010	08	009	09	007
16	12	016	13	015	15	019	15	017	13	006	07	005	09	013
18	12	015	13	015	15	016	15	017	13	006	08	006	06	013
20	13	019	13	016	15	016	16	017	16	014	20	004	08	011
23	14	020	14	015	--	--	16	023	17	010	16	007	08	013
25	13	019	14	019	16	019	15	020	17	010	16	006	10	010
30	16	018	14	014	14	014	14	017	19	008	16	007	17	003
35	14	015	13	014	14	010	14	014	16	009	14	005	14	008
40	13	013	12	017	13	022	11	014	10	014	11	014	13	008
45	07	015	09	020	07	019	09	016	08	015	07	013	09	007
50	10	015	09	011	12	010	16	018	14	007	15	005	09	003
55	13	006	15	006	14	005	07	007	04	010	05	010	09	010
60	10	029	11	010	--	--	08	027	08	026	07	028	09	004
65	08	026	--	--	--	--	09	029	10	030	09	028	10	010
70	10	034	--	--	--	--	09	037	09	036	09	034	09	035
75	10	053	--	--	--	--	09	049	09	047	08	045	10	050
80	10	064	--	--	--	--	10	058	10	058	--	--	09	058
85	10	072	--	--	--	--	10	061	09	068	--	--	09	066
90	10	076	--	--	--	--	09	063	09	073	--	--	--	--

SAN BRUNO 13

TABLE D.4Atmospheric Temperature Data, 13 May 1958

<u>Altitude, feet</u>	<u>Temperature, C°</u>
Surface	27.8
310	26.8
2,231	21.5
4,950	17.2
7,874	11.5
10,310	09.5
14,450	2.5
16,929	- 0.5
18,209	- 2.5
19,095	- 4.2
19,240	- 4.2
19,554	- 4.2
24,920	-14.2
26,903	-18.2
29,331	-23.5
31,070	-28.1
31,870	-30.2
36,036	-39.8
36,050	-40.2
40,930	-51.8
46,850	-65.2
51,810	-75.0
54,680	-77.7
56,859	-79.0
57,684	-75.0
60,621	-74.0
63,030	-77.0
64,482	-62.0
68,120	-63.8
73,656	-56.0
79,167	-57.0
82,540	-50.0
94,149	-45.0

SAN BRENO ITC

TABLE D.5Atmospheric Temperature Data, 15 June 1958

<u>Altitude,</u> <u>feet</u>	<u>Temperature,</u> <u>C°</u>
Surface	25.2
310	24.2
4,910	14.8
5,348	12.0
8,202	9.8
10,240	7.2
11,417	5.5
13,123	2.5
14,350	0.5
16,240	- 2.8
19,080	- 8.5
24,640	-19.2
31,440	-34.5
34,056	-40.2
35,550	-44.0
40,330	-57.0
46,140	-68.0
53,460	-79.0
53,900	-78.0
57,618	-76.0
60,555	-79.0
61,083	-68.0
64,680	-70.0
65,703	-66.0
67,270	-66.8
69,300	-67.0
70,257	-62.0
73,920	-63.0
76,197	-60.0
78,804	-62.0
79,629	-56.0
81,390	-54.0
96,947	-42.0

SAN BRUNO IBC

TABLE D.6Atmospheric Temperature Data, 29 June 1958

<u>Altitude,</u> <u>feet</u>	<u>Temperature,</u> <u>C°</u>
Surface	25.5
280	25.2
3,900	16.8
4,890	15.5
10,210	7.2
14,320	- 0.2
19,050	- 7.2
24,640	-17.8
31,490	-32.8
31,560	-33.2
35,620	-42.2
40,420	-55.2
42,910	-62.0
46,240	-68.2
48,850	-74.0
49,740	-77.0
50,590	-71.0
56,050	-74.8
57,590	-78.0

SAN BRUNO FIRE

APPENDIX EDerivation of Formula for Percent Mo Left in Cloud

The formula given in Chapter 3 for the percent Mo⁹⁹ left in the cloud is based on a material balance for some nuclide, Y. It can be derived as follows:

Let Y_E = atoms Y formed in the explosion

Y_C = " " left in cloud

Y_{FO} = " " in fallout

Mo_E = atoms Mo⁹⁹ formed in the explosion

Mo_C = " " left in the cloud

Mo_{FO} = " " in the fallout

y = fraction of Mo⁹⁹ atoms left in cloud

k = the ratio atoms Y: atoms Mo⁹⁹ formed in thermal neutron fission, a constant

$[R^{99}(Y)]_E$ = R-value for nuclide Y in explosion

$[R^{99}(Y)]_C$ = " " " " " " cloud

$[R^{99}(Y)]_{FO}$ = " " " " " " fallout

$$Y_E = Y_C + Y_{FO} \quad \dots\dots (1)$$

$$= Mo_E \times Y_E / Mo_E$$

$$= Mo_E \times k \times [R^{99}(Y)]_E$$

SAN BRUNO ERG

since $[R^{99}(Y)]_E = [Y_E/Mo_E] : k$

$$Y_C = Mo_C \times Y_C/Mo_C$$

$$= Mo_C \times k \times [R^{99}(Y)]_C$$

since $[R^{99}(Y)]_C = [Y_C/Mo_C] : k$

$$Y_{Fo} = Mo_{Fo}/Mo_{Fo}$$

$$= Mo_{Fo} \times k \times [R^{99}(Y)]_{Fo} \text{ since } [R^{99}(Y)]_{Fo} = Y_{Fo}/Mo_{Fo}$$

$$Mo_E \times k \times [R^{99}(Y)]_E = Mo_E \times k \times y \times [R^{99}(Y)] -$$

$$Mo_E \times (1-y) \times k \times [R^{99}(Y)]_{Fo} \text{ from (1)}$$

$$y = \frac{[R^{99}(Y)]_E - [R^{99}(Y)]_{Fo}}{[R^{99}(Y)]_C - [R^{99}(Y)]_{Fo}}$$

SAN BRUNO FRG

REFERENCES

1. Conference, Atomic Energy Commission, Washington, D. C., 10 June 1957.
2. Fallout Project Planning Conference, Headquarters, AFSWP, Washington, D. C., 12-13 September 1957.
3. J. Frenkel; "Kinetic Theory of Liquids"; Oxford Press, 1946.
4. J. L. Magee; "Particle Size of Debris from the Atomic Bomb, Appendix II"; Rand Corporation, World Wide Effects of Atomic Weapons, Project Sunshine, R-251-AEC, 6 August 1953; SECRET-RD.
5. K. Stewart; "The Condensation of a Vapor to an Assembly of Droplets (with Particular Reference to Atomic Explosion Debris)"; Trans. Faraday Soc. 52, 161-73 (1956).
6. E. C. Freiling; "Recent Developments in the Study of Fractinnation, I"; USNRDL Technical Memorandum No. 73, 25 July 1957; CONFIDENTIAL-RD.
7. R. D. Evans; "The Atomic Nucleus"; McGraw-Hill Book Company, 1955.
8. Rand Corporation; "World Wide Effects of Atomic Weapons, Project Sunshine"; R-251-AEC, 6 August 1953; SECRET-RD.
9. C. E. Adams; "Fallout Particles from Shots Zuni and Tewa, Operation REDWING"; USNRDL-TR-133, 1957; CONFIDENTIAL.
10. R. C. Tompkins and D. W. Krey; "Mechanism of Fallout Particle Formation: I"; Chemical Warfare Laboratories, Edgewood, Maryland; Technical Report CWLR 2059, 27 November 1956; SECRET-RD.
11. C. E. Adams, N. H. Farlow and W. R. Schell; "The Composition, Structures and Origin of Radioactive Fallout"; USNRDL-TR-209, 3 February 1958; UNCLASSIFIED.
12. C. E. Adams and J. D. O'Connor; "The Nature of Radioactive Particles: VI, Fallout Particles from a Tower Shot, Operation REDWING"; USNRDL Report in Publication; UNCLASSIFIED.

SAN BRUNO FRC

13. T. Triffet and P. D. LaRiviere; "Operation REDWING, Project 2.63 Final Report" WT-1317; August 1958; SECRET-RD.
14. N. G. Stewart, R. N. Crooks and E. M. R. Fisher; "The Radiological Dose to Persons in the U. K. due to Debris from Nuclear Test Explosions prior to January 1956"; AERE HP/R-2017; UNCLASSIFIED.
15. E. R. Tompkins and L. B. Werner; "Chemical, Physical and Radiochemical Characteristics of the Contaminant"; Project 2.6a, Operation CASTLE, WT-917, September, 1955; Naval Radiological Defense Laboratory, San Francisco, California; SECRET-RD.
16. S. M. Greenfield, W. W. Kellogg, F. J. Krieger and R. R. Rapp; "Transport and Early Deposition of Radioactive Debris from Atomic Explosions"; Project Aureole, R-265-AEC, 1 July 1954; SECRET-RD.
17. L. Machta; "Entrainment and the Maximum Height of the Atomic Cloud"; Bulletin Am. Meteor. Soc., 31, 215 (1950); UNCLASSIFIED.
18. I. C. Cheeseman and D. Sams; "On the Rise of an Atomic Cloud"; AWRE Report E9/57, August, 1957; UNCLASSIFIED.
19. R. R. Soule and T. H. Shirasawa; "Rocket Determination of Activity Distribution Within the Stabilized Cloud"; Project 2.61, Operation REDWING, WT-1315, Draft Manuscript; Naval Radiological Defense Laboratory, San Francisco, California; SECRET-RD.
20. A. D. Anderson; "A Theory for Close-In Fallout", USNRDL-TR-249; 23 July 1958; UNCLASSIFIED.
21. E. A. Schuert; "A Fallout Forecasting Technique with Results Obtained At the Eniwetok Proving Grounds"; USNRDL-TR-139, 3 April 1957; UNCLASSIFIED.
22. J. M. Dallavalle; "Micromeritics"; Pittmann Publishing Corporation, 1948; UNCLASSIFIED.
23. Hearings before the Special Subcommittee on Radiation of the Joint Committee on Atomic Energy, Congress of the United States, Eighty-fifth Congress; First Session on "The Nature of Radioactive Fallout and its Effects on Man"; Part 1, May 27, 28, 29 and June 3, 1957;

U. S. Government Printing Office, Washington, D. C.; UNCLASSIFIED.

24. Ibid., Part 2, June 4, 5, 6 and 7, 1957; UNCLASSIFIED.
25. L. B. Werner; "Percent of Weapon Debris Removed by Local Fallout"; Review and Lectures No. 39, USNRDL 28 August 1957; SECRET-RD.
26. Rand Fallout Symposium, AFSWP-1050, 1 April 1957; SECRET-RD.
27. N. M. Lulejian; "Radioactive Fallout from Atomic Bombs"; Report CS-36417, Air Research and Development Command, November 1953; SECRET-RD.
28. R. D. Cadle; "Effects of Soil, Yield, and Scaled Depth on Contamination from Atomic Bombs"; Stanford Research Institute, Menlo Park, California; Cm. C. Contract DA-18-108-CML-3842, 29 June 1953; SECRET-RD.
29. R. L. Stetson and others; "Distribution and Intensity of Fallout"; Project 2.5a, Operation CASTLE. WT-915, January 1956; U.S. Naval Radiological Defense Laboratory, San Francisco, California; SECRET-RD.
30. T. R. Folsom and L. B. Werner; "Distribution of Radioactive Fallout by Survey and Analysis of Contaminated Sea Water"; Project 2.7, Operation CASTLE, WT-935, Draft Manuscript; Scripps Institution of Oceanography, La Jolla, California and U.S. Naval Radiological Defense Laboratory, San Francisco, California; SECRET-RD.
31. D. C. Borg, L. D. Gates, T. A. Gibson, Jr., and R. W. Paine, Jr.; "Radioactive Fallout Hazards from Surface Bursts of Very High Yield Nuclear Weapons"; AFSWP-507; May 1954; SECRET-RD.
32. R. C. Tompkins; "Radiochemical Estimation of Total Activity Included Within Dose Rate Contours for Bravo Shot, Operation CASTLE"; CRLR 636, Army Chemical Center, Edgewood, Maryland, March 1956; SECRET-RD.
33. H. D. Levine and R. T. Graveson; "Radioactive Debris from Operation CASTLE, Aerial Survey of Open Sea Following Yankee-Nectar; NYOO-4618, 20 December 1954; SECRET-RD.

SAN BRUNO IBC

34. N. E. Ballou; "Radiochemical and Physical Chemical Properties of Products of a Deep Underwater Nuclear Detonation"; Project 2.3, Operation WIGWAM, WT-1011, April 1957; U. S. Naval Radiological Defense Laboratory; SECRET-RD.
35. R. L. Stetson and others; "Distribution and Intensity of Fallout from the Underground Shot"; Operation TEAPOT, WT-1154, March 1958; U. S. Naval Radiological Defense Laboratory, San Francisco, California; CONFIDENTIAL-RD.
36. V. A. J. Van Lint, L. E. Killion, J. A. Chiment and D. C. Campbell; "Fallout Studies during Operation REDWING"; Preliminary Report Program 2 Summary, ITR 1354, October 1956; Field Command, Armed Forces Special Weapons Project, Washington, D. C.; SECRET-RD.
37. B. L. Tucker; "Fraction of REDWING Activity in Local Fallout"; Rand Corporation Report, 9 July 1957; SECRET-RD.
38. W. F. Libby; "Radioactive Strontium in Fallout"; Proc. Nat. Acad. Sci. 42, No. 6, pp. 365-390, June 1956; UNCLASSIFIED.
39. W. F. Libby; "Current Research Findings on Radioactive Fallout"; Proc. Nat. Acad. Sci. 42, 945-964; December 1956; UNCLASSIFIED.
40. A. G. Hoard, Merrill Eisenbud and J. H. Harley; "Annotated Bibliography on Fallout Resulting from Nuclear Explosions"; NYO-4753, September 1956; UNCLASSIFIED.
41. A. G. Hoard, Merrill Eisenbud and J. H. Harley; "Annotated Bibliography on Long Range Effects of Fallout from Nuclear Explosions"; NYO-4753, Supplement 1, November 1956; UNCLASSIFIED.
42. A. J. Breslin and M. E. Cassidy; "Radioactive Debris from Operation CASTLE, Islands of the Mid-Pacific"; NYO-4623, January 1955; SECRET-RD.
43. C. T. Rainey and others; "Distribution and Characteristics of Fallout at Distances Greater than Ten Miles from Ground Zero"; Project 27.1, UPSHOT-KNOTHOLE, WT-811, February 1954; University of California, Los Angeles, California; SECRET-RD.

SAN BRUNO TRG

44. K. H. Larson; "Radio-Ecological Aspects of Nuclear Fallout"; Operation PLUMBBOB, Program 37; Department of Agriculture; UNCLASSIFIED.
45. J. Lockhart, R. A. Baus and J. H. Blifford; "Atmospheric Radioactivity along the 80th Meridian, 1956"; NRL Report 4965, July 23, 1957; UNCLASSIFIED.
46. R. D. Maxwell and others; "Evaluation of Radioactive Fallout"; AFSWP 978, 15 September 1955; SECRET-RD.
47. L. F. Hubert, L. Machta and R. J. List; "A Meteorological Analysis of the Transport of Debris from Operation IVY"; U. S. Weather Bureau, NYO-4555, October 1953; SECRET-RD.
48. L. Machta and R. J. List; "Analysis of Atmospheric Sr⁹⁰ Measurements"; U. S. Weather Bureau, March 1959; UNCLASSIFIED.
49. N. E. Ballou and L. R. Bunney; "Nature and Distribution of Residual Contamination, II"; Operation JANGLE, WT-397, June 1952; U. S. Naval Radiological Defense Laboratory, San Francisco, California; SECRET-RD.
50. P. C. Stevenson; Chemistry Division, University of California Radiation Laboratory, Livermore, California. Private Communication.
51. R. W. Spence and G. A. Cowan; Group J-11, Los Alamos Scientific Laboratory; UNCLASSIFIED.
52. K. Street; Chemistry Division, University of California Radiation Laboratory, Livermore, California.
53. Philip Krey; "AFSWP Fallout Symposium"; AFSWP-895, January 1955; SECRET-RD.
54. L. R. Bunney and N. E. Ballou; "Bomb Fraction Measurement Techniques"; USNRDL-TR-176; 11 September 1957; SECRET-RD.
55. P. C. Stevenson, H. G. Hicks, W. E. Nervik and H. B. Levy; "Correlation of Fractionation Phenomena in Tewa Event, Operation RED-WING"; UCRL 5027, 21 November 1957; SECRET-RD.

SAN BRUNO FRG

56. Lt R. Bunney and E. C. Freiling; "Recent Developments in the Study of Fractionation, II"; USNRDL Technical Memorandum No. 81, 19 February 1958; CONFIDENTIAL-RD.
57. A. W. Goodrich; "A Rocket System for Sampling Particulate Matter Contained in Nuclear Clouds"; Cooper Development Corporation, Monrovia, California, 31 January 1959; UNCLASSIFIED.
58. Private Communication, Dr. T. Triffet, USNRDL.
59. " " , E. A. Schuert, USNRDL.
60. " " , Dr. G. Cowan, LASL.
61. C. W. Bastian, R. Robbiani and J. Hargrave; "X-Band Radar Determination of Nuclear Cloud Parameters"; U. S. Army Signal Research and Development Laboratory, Fort Monmouth, New Jersey, 13 October 1958; SECRET-RD.
62. L. R. Bunney, E. C. Freiling, L. D. McIsaac and E. H. Scadden; "Radiochemical Procedure for Individual Rare Earths"; Nucleonics 15, No. 2, 81-83 (1957).
63. L. E. Glendenin; "Determination of Strontium and Barium Activities In Fission"; Paper 236 in NNES, Div. IV, 9, 1460, edited by C. D. Coryell and N. Sugarman, McGraw-Hill Book Company, 1951.
64. E. J. Hoagland; "Note on the Determination of Strontium as the Carbonate"; Paper 237, Ibid.
65. J. B. Niday; "Radiochemical Procedure for Cesium"; UCRL-4377, p. 13, 10 August 1954.
66. J. Kleinberg (editor); "Collected Radiochemical Procedures"; LA-1721, Second edition, 18 August 1958.
67. L. Wish; "Quantitative Radiochemical Analysis by Ion Exchange; Anion Exchange Behaviour in Mixed Acid Solutions and Development of a Sequential Separation Scheme"; Anal. Chem. 31, 326 (1959).
68. E. Scadden; "Improved Molybdenum Separation Procedure"; Nucleonics 15, No. 4, 102 (1957).

SAN BRUNO PROC